

1:	9.4	↓
2:	10.2	↘
3:	10.2	→
4:	10.4	↘
5:	10.4x	↑
Serie		49.0
Total		0.0

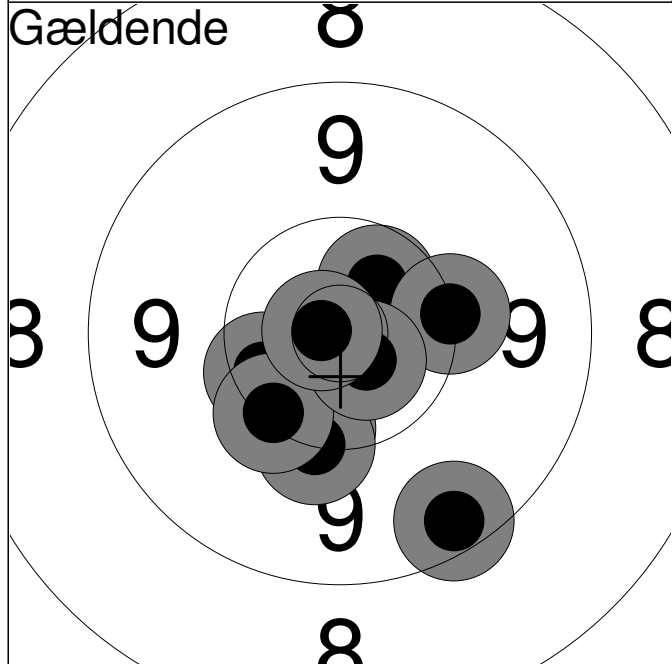

1:	10.8x	↙
2:	10.3	↘
3:	10.5x	↗
4:	10.2	↘
5:	10.4	↙
6:	9.4	↘
7:	10.2	→
8:	10.2	↙
9:	10.7x	↘
10:	10.8x	←
Serie		99.0
Total		99.0

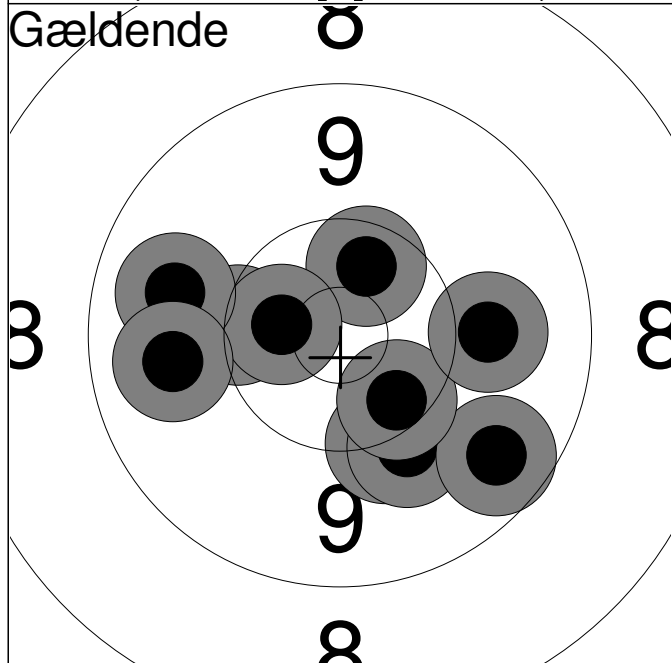

11:	10.2	←
12:	10.1	↘
13:	10.4x	↗
14:	10.1	↘
15:	10.5x	←
16:	9.6	↘
17:	9.8	←
18:	10.4	↘
19:	9.8	←
20:	9.9	→
Serie		96.0
Total		195.0

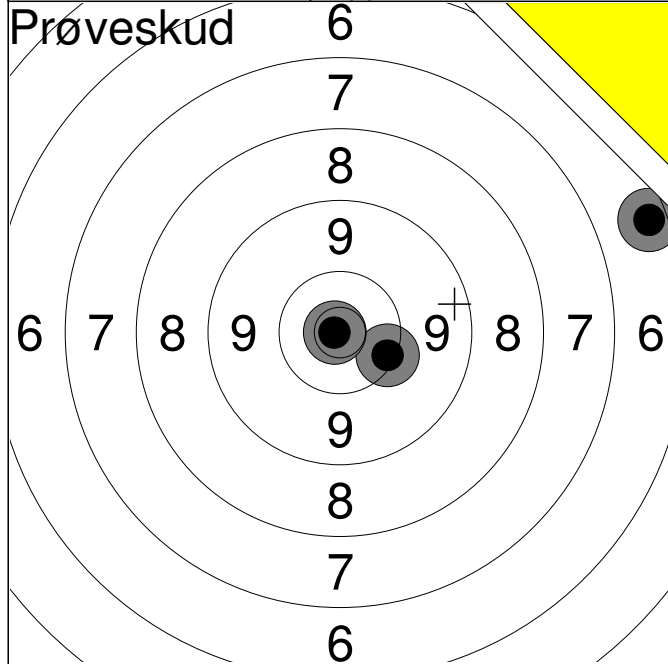

	1:	6.4	→
	2:	10.3	→
	3:	10.9x	←
Serie			26.0
Total			0.0

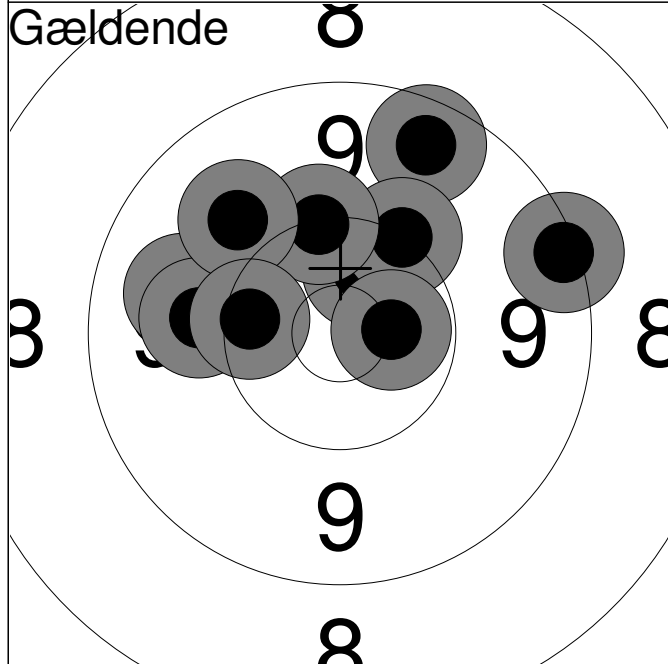

	1:	10.5x	↑
	2:	9.3	→
	3:	9.5	↑
	4:	10.2	↗
	5:	9.8	←
	6:	10.0	←
	7:	10.2	↑
	8:	9.9	↗
	9:	10.6x	→
	10:	10.3	←
Serie			96.0
Total			96.0

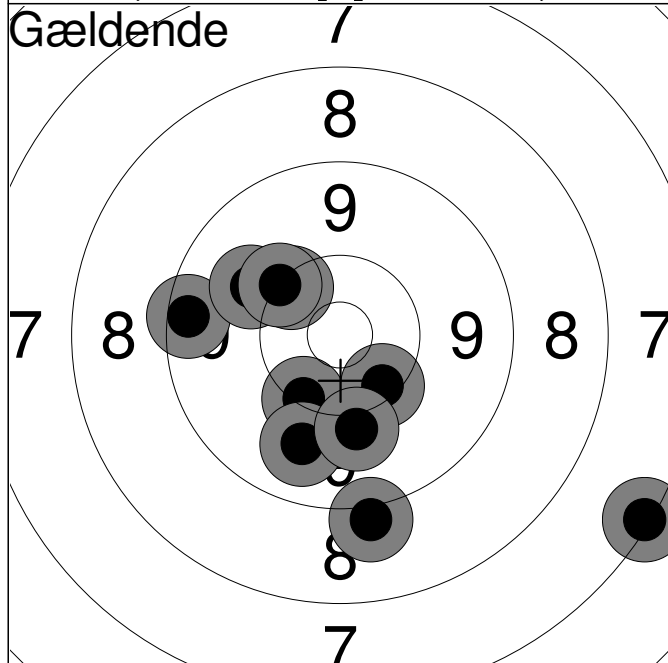

	11:	10.2	↘
	12:	10.3	↘
	13:	9.8	↘
	14:	7.2	↘
	15:	9.0	↘
	16:	10.0	↘
	17:	10.3	↗
	18:	9.4	←
	19:	10.0	↗
	20:	10.2	↗
Serie			94.0
Total			190.0

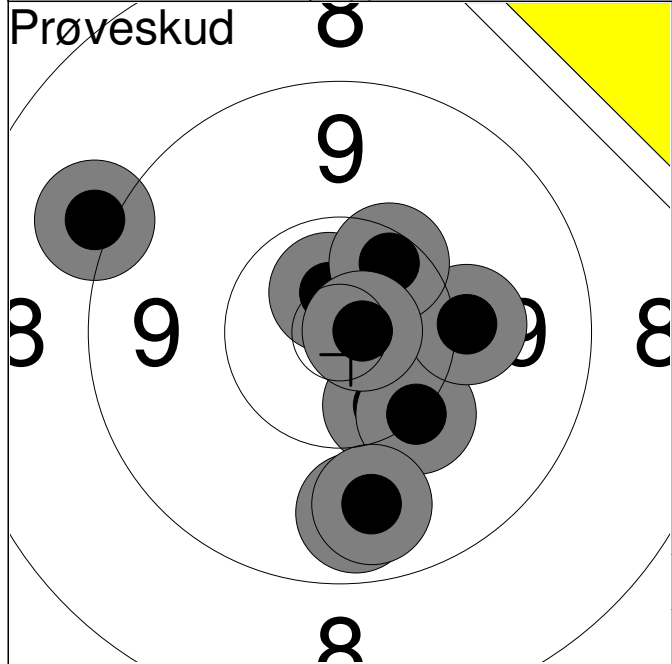

1:	9.0	↗
2:	10.4	↘
3:	10.2	↘
4:	9.7	↘
5:	10.7x	↗
6:	10.1	→
7:	10.4	↗
8:	9.7	↘
9:	10.8x	→

Serie	87.0
Total	0.0

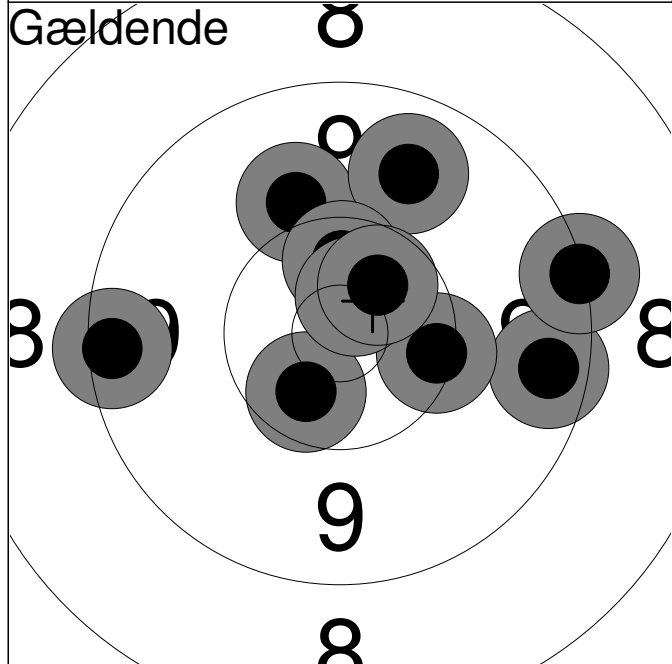

1:	9.5	→
2:	10.0	↗
3:	10.5x	↘
4:	9.7	↗
5:	10.3	→
6:	9.2	→
7:	9.3	←
8:	10.5x	↗
9:	10.7x	↗
10:	10.5x	↗

Serie	96.0
Total	96.0

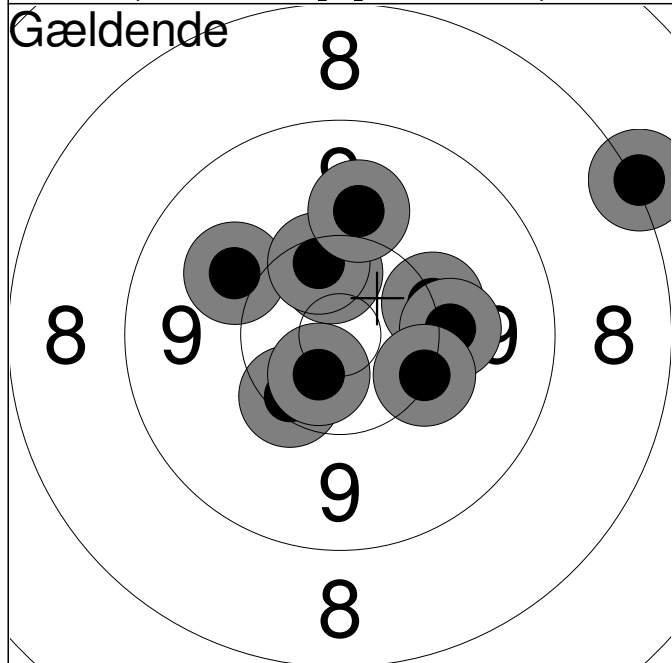

11:	8.1	↗
12:	10.2	→
13:	10.1	→
14:	10.4x	↗
15:	10.3	↘
16:	10.6x	↘
17:	10.2	→
18:	10.0	↗
19:	10.4	↗
20:	10.0	↗

Serie	98.0
Total	194.0

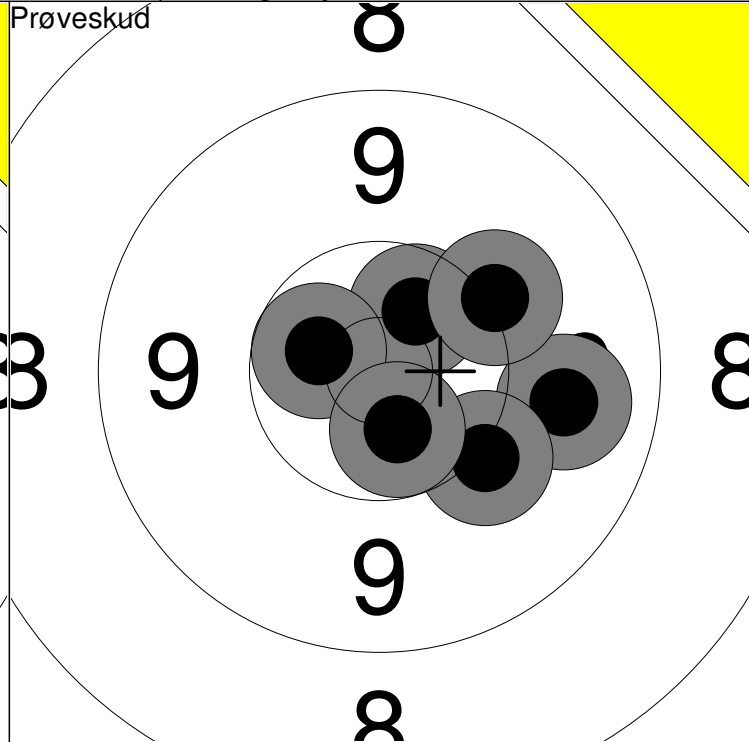
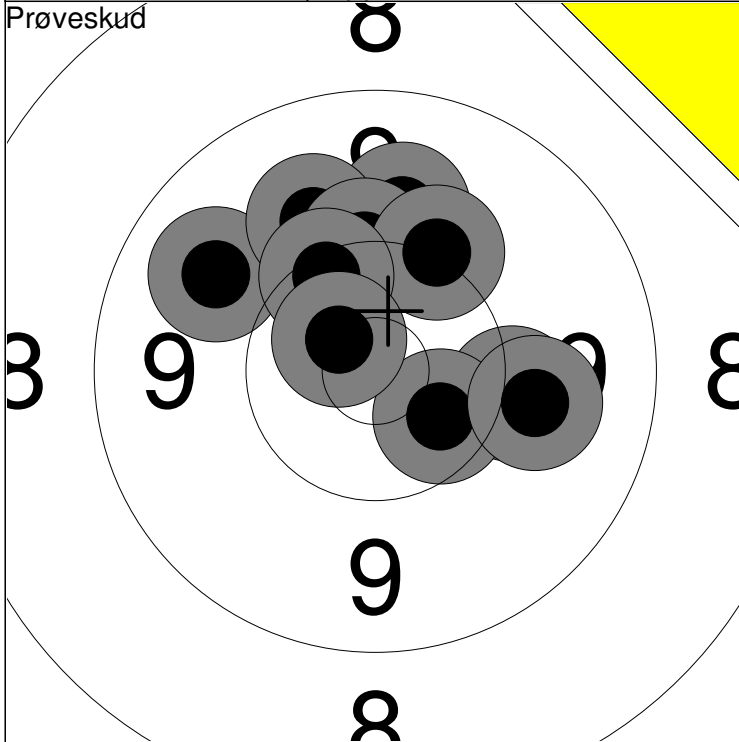

1: 10.0 ↑	6: 10.2 ↑	Serie	99
2: 10.1 →	7: 10.1 ↗		
3: 10.5x ↘	8: 10.3 ↗	Total	0
4: 9.8 ↖	9: 10.7x ↗		
5: 10.0 ↗	10: 10.0 →		

11: 10.5x ↗	16: 10.6x ↓	Serie	59
12: 9.8 →	13: 10.1 ↘		
14: 10.1 ↗	15: 10.6x ←	Total	0

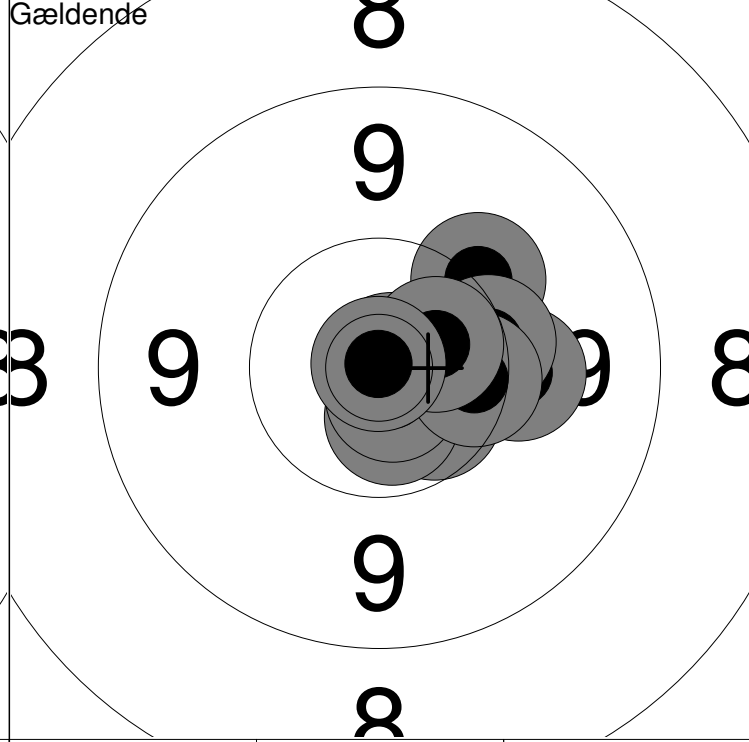
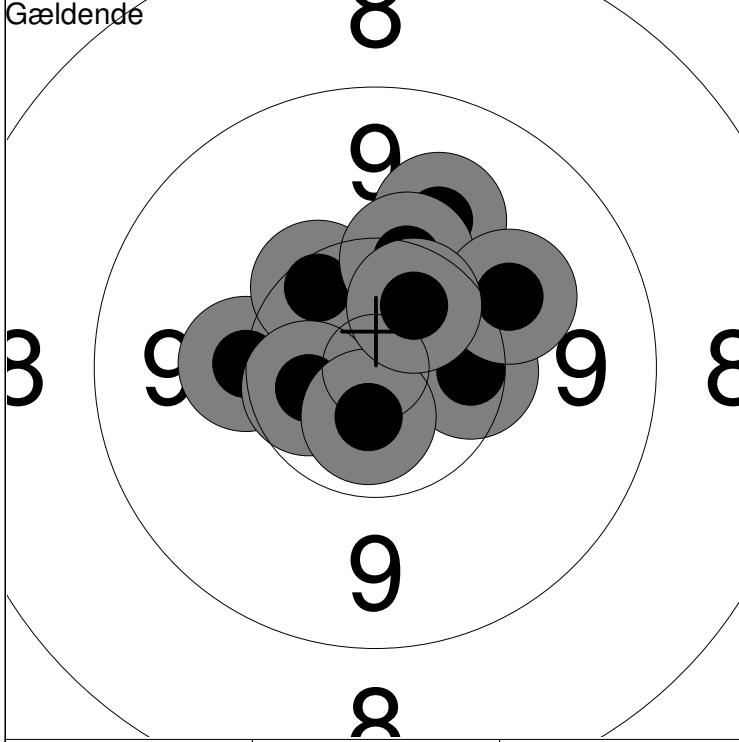

1: 10.0 ↑	6: 10.3 ↑	Serie	100
2: 10.4 →	7: 10.5x ←		
3: 10.7x ←	8: 10.6x ↓	Total	100
4: 10.2 ←	9: 10.0 ↗		
5: 10.3 ↗	10: 10.5x ↗		

11: 10.9x ↗	16: 10.3 →	Serie	100
12: 10.5x ↘	17: 10.8x ↓		
13: 10.6x ↓	18: 10.4 →	Total	200
14: 10.1 ↗	19: 10.6x ↗		
15: 10.1 →	20: 10.9x ↑		

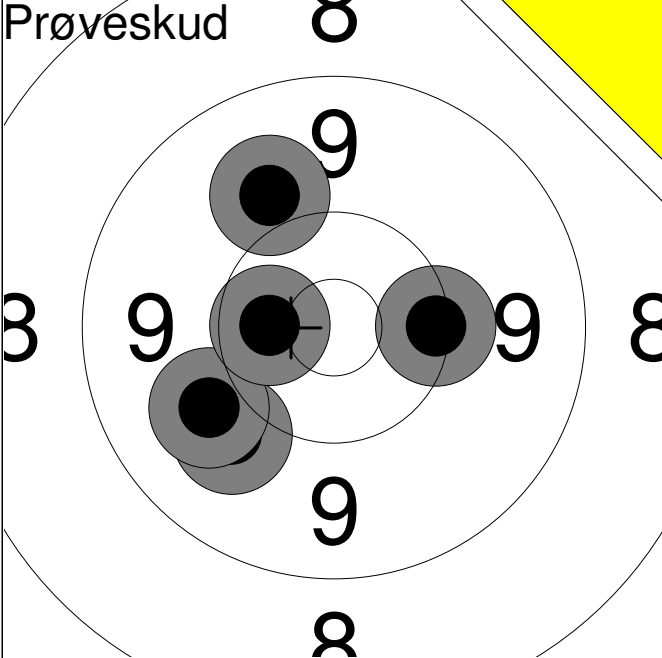
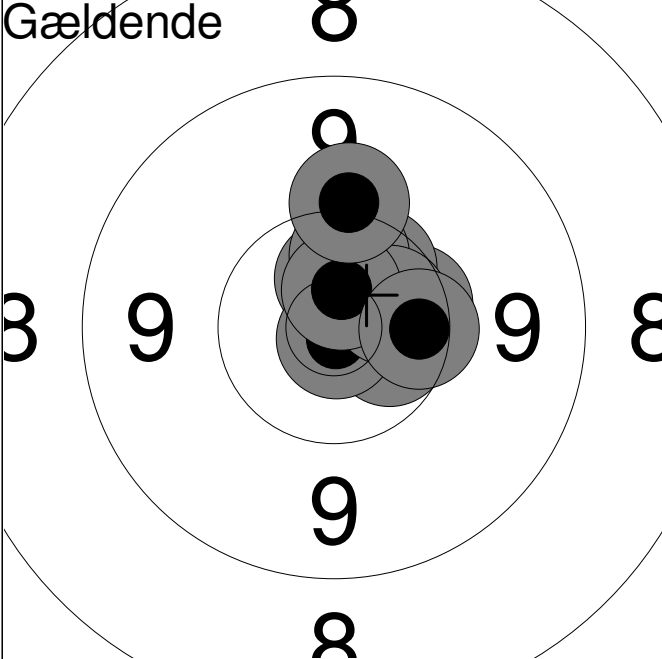
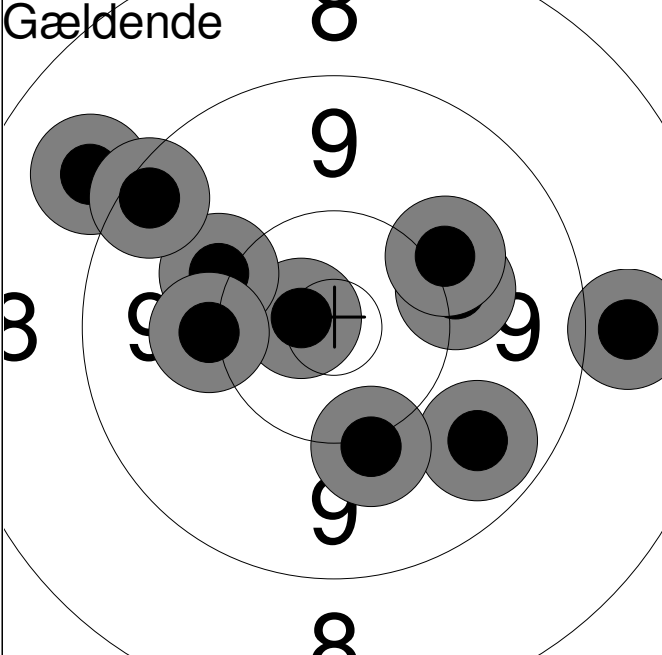
Hold	Skive	Camilla Chemnitz Hansen		
8	3	Randers Skyttekreds		M1
50m	Jeppestævne 2015		Aalborg Skyttekreds	
Prøveskud		1:	9.9	↙
		2:	9.9	↙
		3:	10.5x	←
		4:	9.9	↗
		5:	10.3	→
		Serie		47.0
Total		0.0		
Gældende		1:	10.4	→
		2:	10.5x	↘
		3:	10.4x	↗
		4:	10.6x	↑
		5:	10.9x	↓
		6:	10.4x	↑
		7:	10.5x	→
		8:	10.7x	↑
		9:	10.1	↑
		10:	10.4	→
		Serie		100.0
Total		100.0		
Gældende		11:	8.9	↗
		12:	9.7	↘
		13:	10.7x	←
		14:	10.1	↗
		15:	10.1	↓
		16:	8.9	→
		17:	10.1	→
		18:	10.1	←
		19:	10.0	↗
		20:	9.4	↖
		Serie		94.0
Total		194.0		

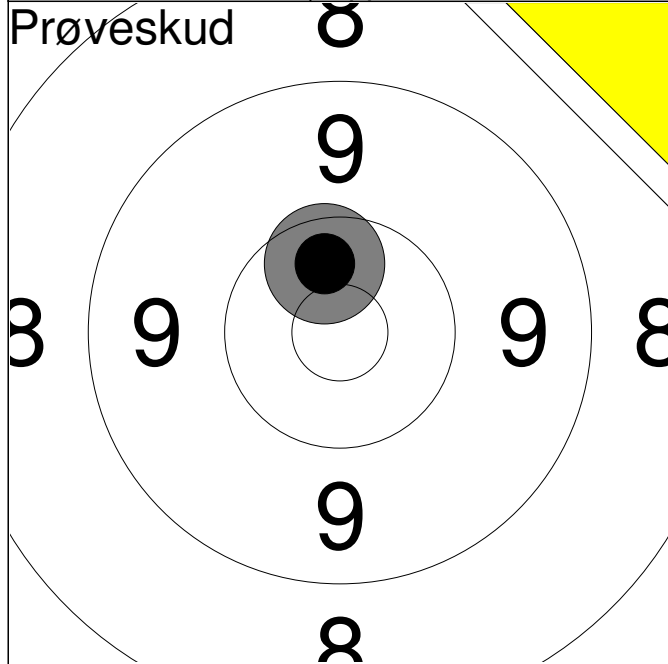

1:	10.5x	↑
Serie	10.0	
Total	0.0	

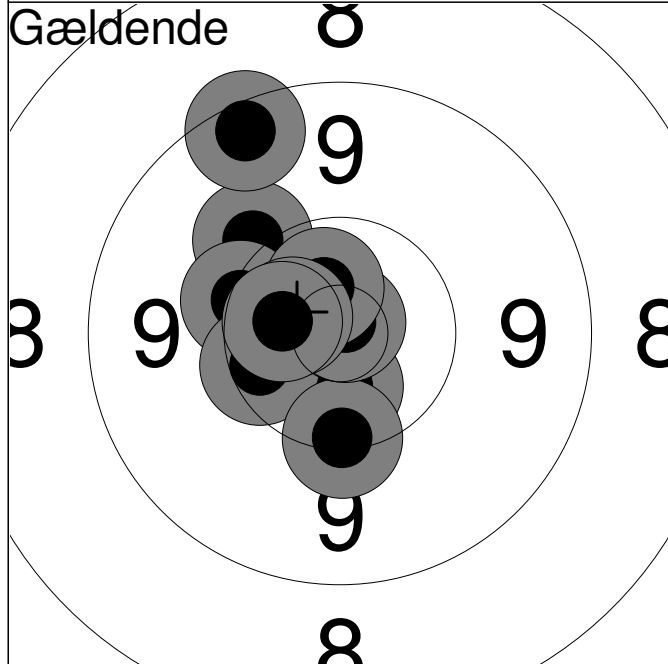

1:	10.1	↗
2:	9.4	↗
3:	10.2	↖
4:	10.6x	↓
5:	10.4	↖
6:	10.2	↓
7:	10.9x	↗
8:	10.6x	↗
9:	10.6x	↖
10:	10.6x	↖
Serie	99.0	
Total	99.0	

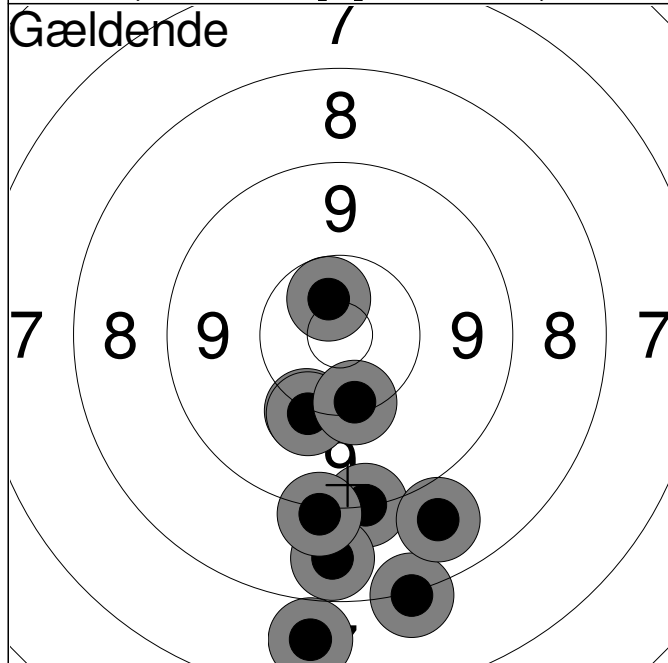

11:	10.1	↘
12:	9.2	↘
13:	7.8	↘
14:	8.1	↘
15:	8.6	↘
16:	10.1	↖
17:	10.3	↘
18:	8.8	↘
19:	9.1	↘
20:	10.6x	↗
Serie	89.0	
Total	188.0	

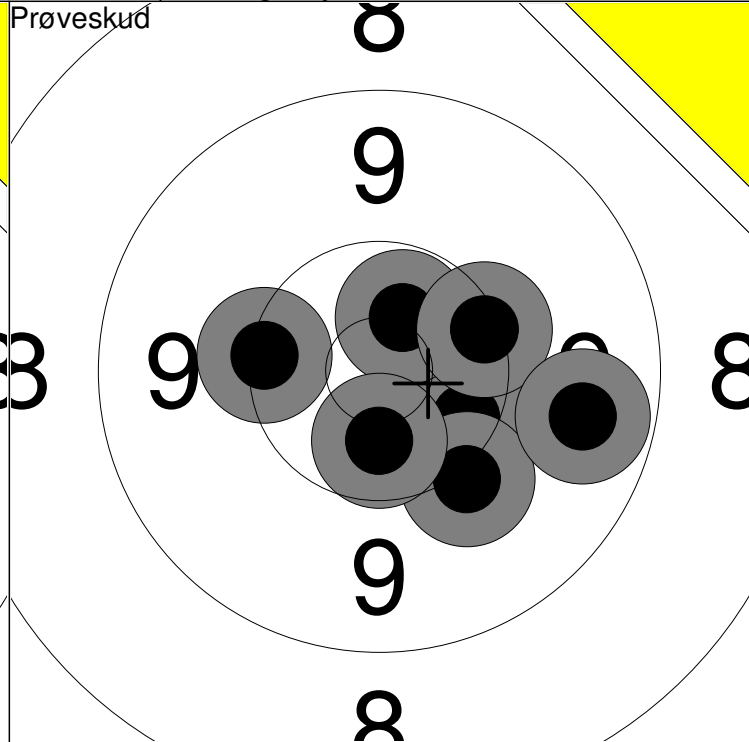
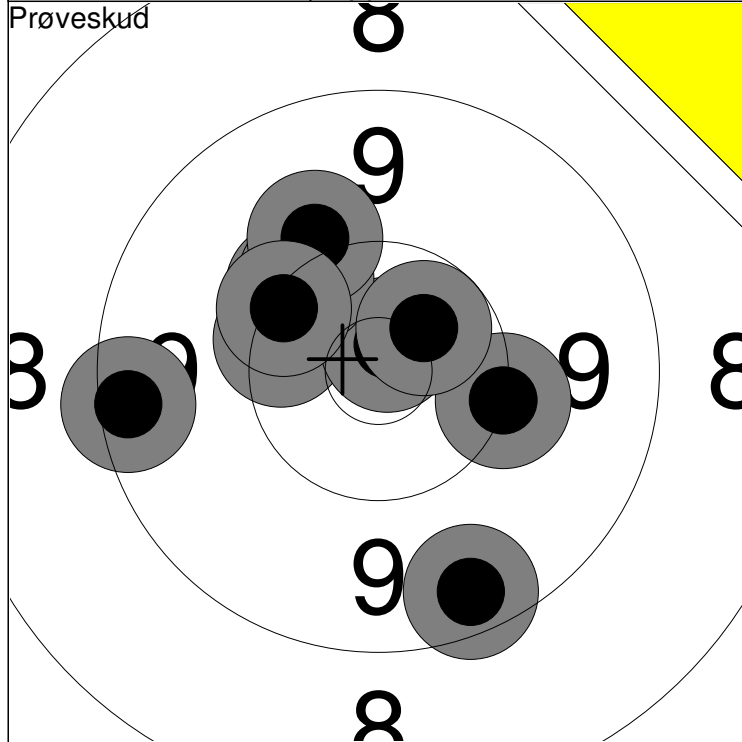

1: 10.2 ↗	6: 10.1 ↗	Serie	98
2: 10.3 ↖	7: 10.6x ↗		Total
3: 10.8x ↗	8: 9.5 ↘		
4: 10.2 ↗	9: 10.3 ↗		
5: 10.2 →	10: 9.4 ←		

11: 10.3 →	16: 10.5x ↓	Serie	69
12: 10.1 ↘	17: 10.2 ←		Total
13: 10.6x ↗			
14: 10.3 →			
15: 9.7 →			

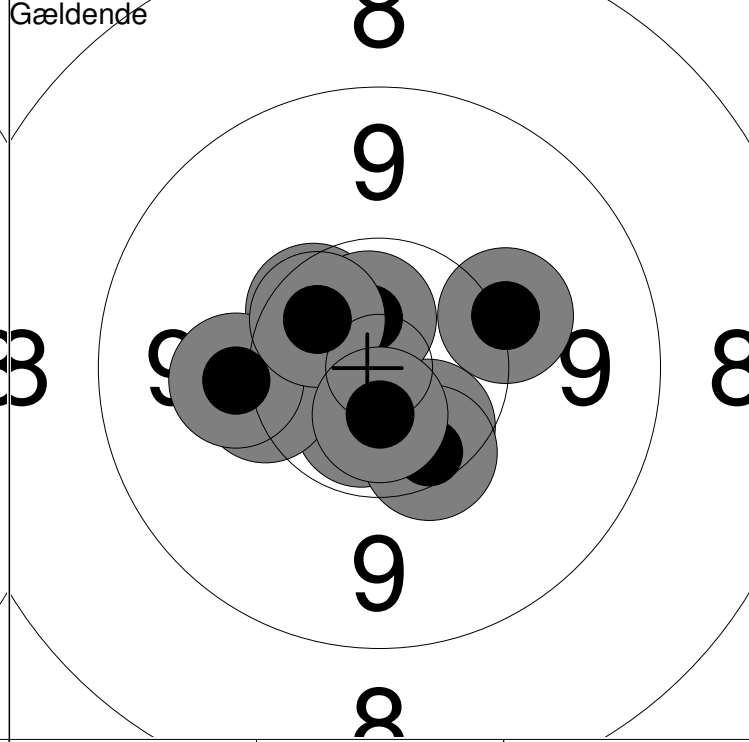
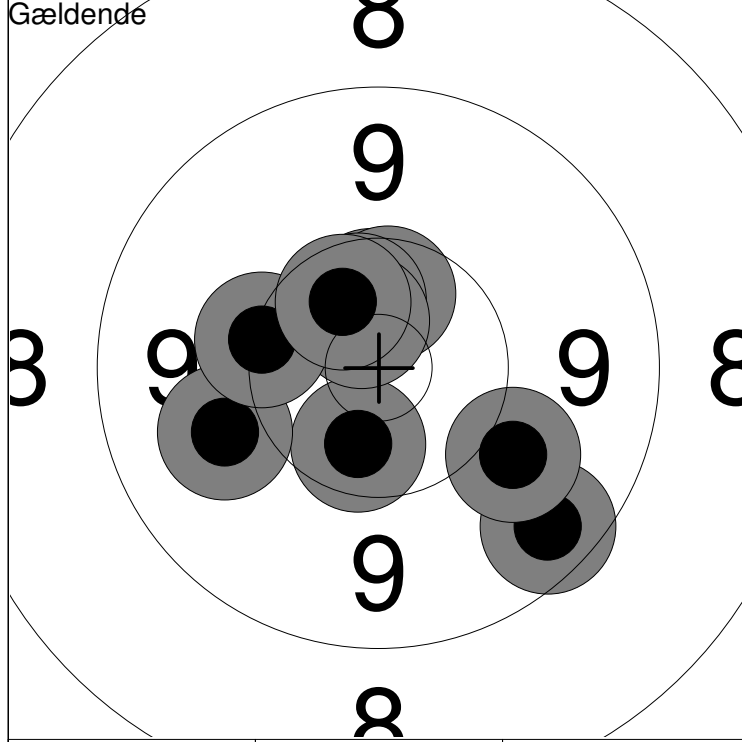

1: 10.5x ↑	6: 10.0 ↘	Serie	98
2: 10.5x ↑	7: 10.6x ↗		Total
3: 9.5 ↘	8: 9.9 ←		
4: 10.5x ↓	9: 10.2 ←		
5: 10.5x ↑	10: 10.5x ↗		

11: 10.4x ↗	16: 10.2 ←	Serie	100
12: 10.6x ↘	17: 10.1 ←		Total
13: 10.1 →	18: 10.5x ↗		
14: 10.5x ↘	19: 10.4 ↘		
15: 10.6x ↗	20: 10.7x ↓		

Hold	Skive	Daniel Mørk		
9	1	Hobro Egnens Skytteforening		ÅK1
50m		Jeppestævne 2015	Aalborg Skyttekreds	
Prøveskud		1:	10.0	↘
		2:	10.1	↑
		3:	9.6	→
		4:	8.9	↗
		5:	10.7x	↑
		6:	9.9	→
		Serie		56.0
Total		0.0		
Gældende		1:	10.5x	↘
		2:	9.6	←
		3:	10.2	↗
		4:	10.0	↘
		5:	10.3	←
		6:	10.6x	↑
		7:	10.5x	↗
		8:	10.5x	←
		9:	10.2	↑
		10:	10.3	←
		Serie		99.0
Total		99.0		
Gældende		11:	10.5x	←
		12:	9.6	←
		13:	10.2	↗
		14:	10.3	↑
		15:	10.4	↘
		16:	10.8x	↑
		17:	10.7x	↗
		18:	10.7x	←
		19:	10.1	↗
		20:	10.4x	↗
		Serie		99.0
Total		198.0		

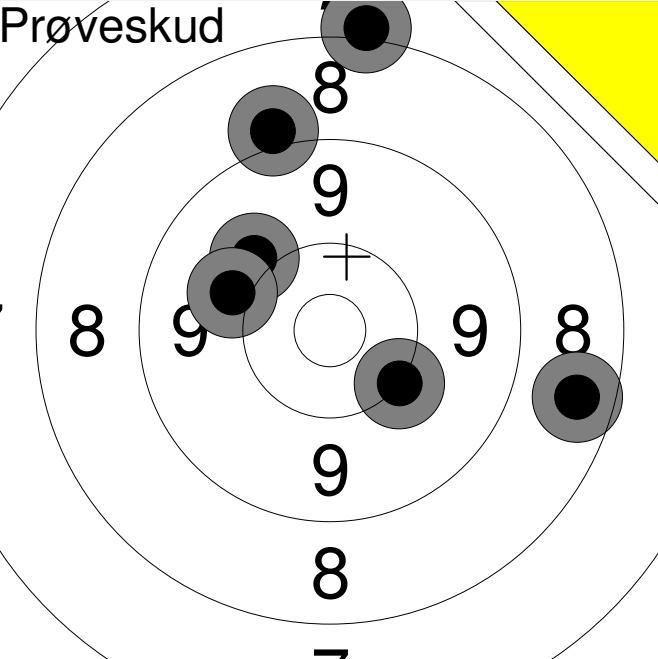
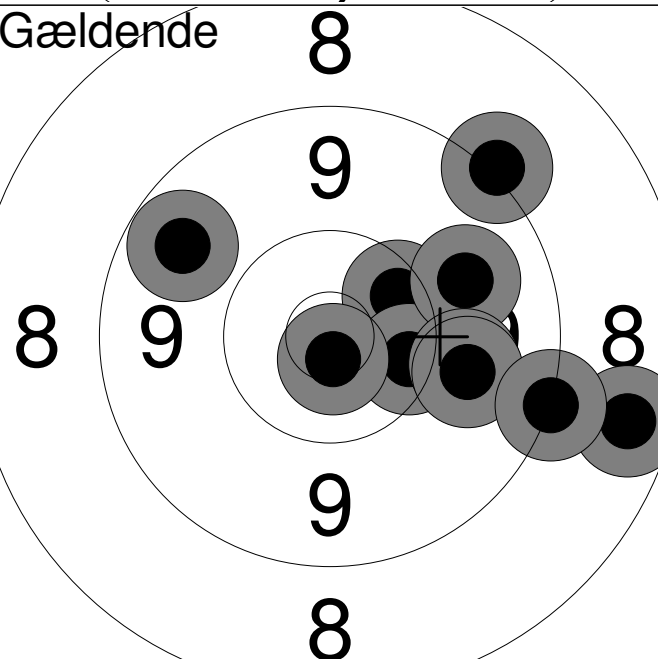
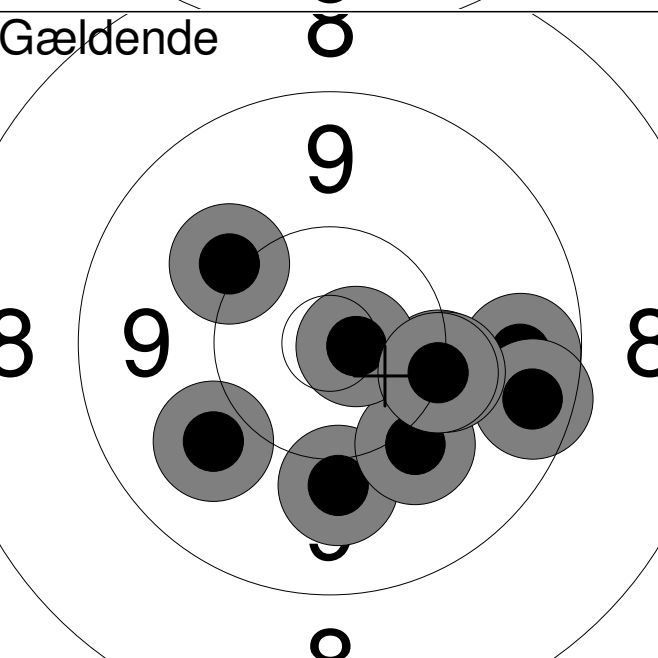
Hold	Skive	Kaj Haulrich	
9	3		
50m	Vodskov Skytteforening	MV2	
	Jeppestævne 2015	Aalborg Skyttekreds	
Prøveskud 	1:	8.1	↑
	2:	10.0	↗
	3:	10.2	↘
	4:	9.0	↗
	5:	8.5	↘
	6:	10.0	↗
	Serie	55.0	
Total	0.0		
Gældende 	1:	9.6	↗
	2:	10.4	↗
	3:	10.3	→
	4:	9.9	↗
	5:	8.5	→
	6:	9.9	→
	7:	10.8x	↓
	8:	9.9	→
	9:	9.1	↗
	10:	9.2	→
Serie	92.0		
Total	92.0		
Gældende 	11:	9.6	→
	12:	9.5	→
	13:	10.2	→
	14:	10.1	↗
	15:	9.9	↖
	16:	10.0	↓
	17:	10.0	↘
	18:	10.8x	→
	19:	10.1	→
	20:	10.2	→
	Serie	97.0	
Total	189.0		

Hold	Skive	Karsten Abildgaard		
9	10	Hobro Egnens Skytteforening		ÅK1
50m		Jeppestævne 2015		Aalborg Skyttekreds
Prøveskud		1:	10.2	←
		2:	8.7	↘
		3:	9.8	↘
		4:	9.4	↘
		5:	10.2	↘
		6:	9.7	↖
		7:	10.3	↘
		8:	10.6x	↗
		9:	10.1	↘
		Serie		85.0
Total		0.0		
Gældende		1:	10.5x	↘
		2:	10.2	↘
		3:	9.8	↘
		4:	10.8x	↘
		5:	10.0	↘
		6:	9.9	→
		7:	10.2	←
		8:	10.4x	↘
		9:	10.8x	↘
		10:	10.3	↘
Serie		98.0		
Total		98.0		
Gældende		11:	9.8	↗
		12:	10.5x	↗
		13:	10.9x	↘
		14:	10.5x	↘
		15:	10.5x	↘
		16:	10.7x	→
		17:	10.7x	←
		18:	10.5x	↘
		19:	10.0	↑
		20:	10.2	←
Serie		99.0		
Total		197.0		

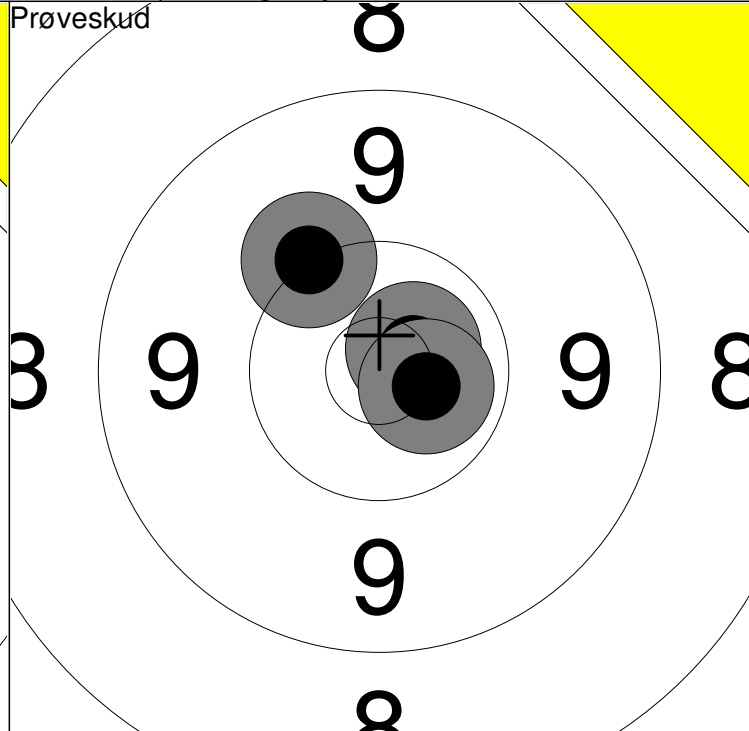
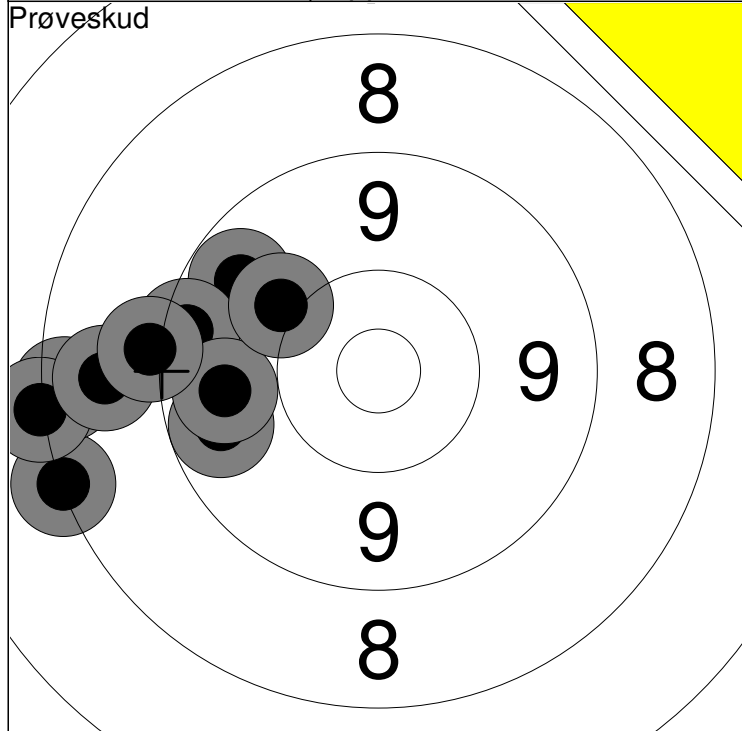

1: 9.6 ↗	6: 8.1 ←	Serie	87
2: 9.6 ←	7: 9.7 ←		
3: 8.2 ←	8: 8.7 ←	Total	0
4: 8.4 ←	9: 9.1 ←		
5: 9.4 ←	10: 10.0 ↗		

11: 10.7x ↗	Serie	30
12: 10.1 ↗		
13: 10.6x ↗	Total	0

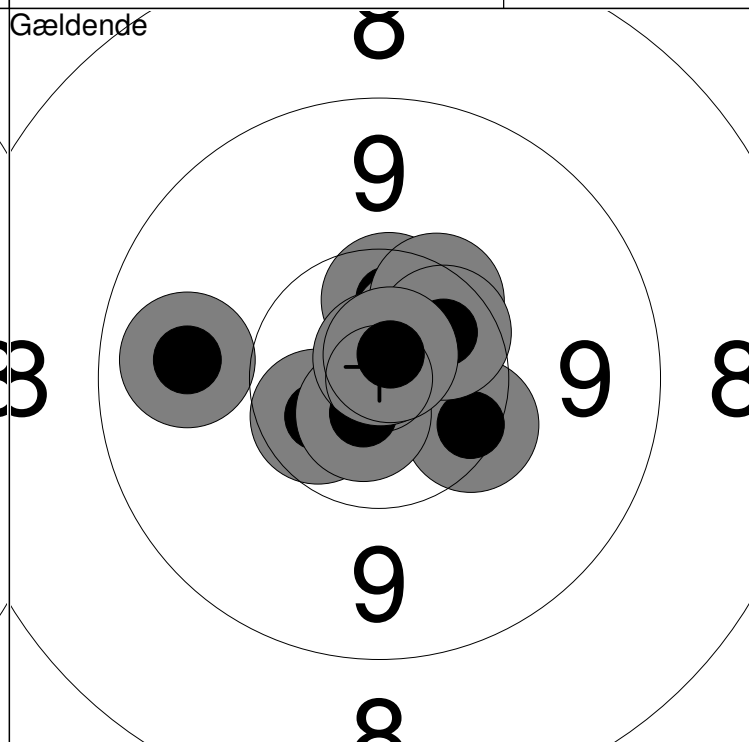
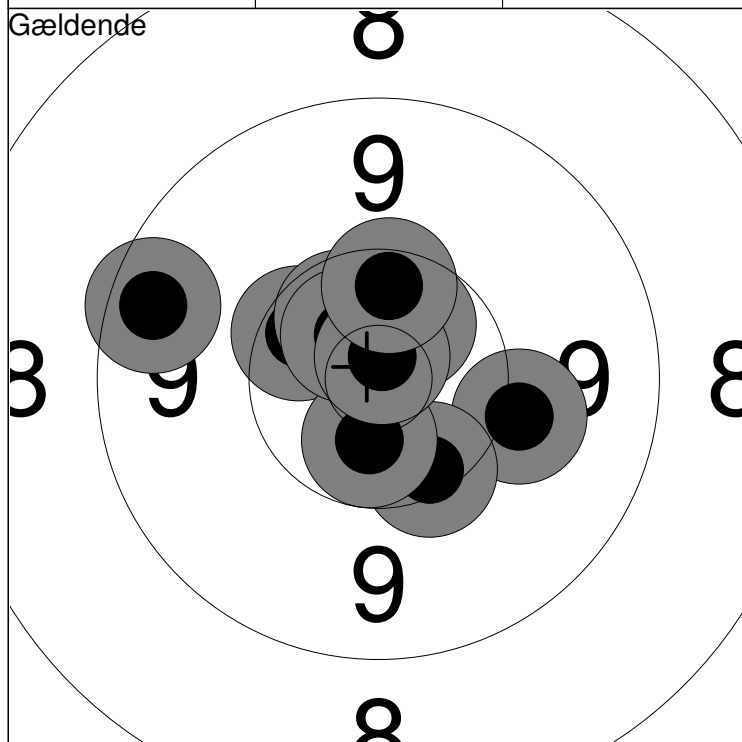

1: 10.4 ↗	6: 10.6x ↗	Serie	99
2: 10.1 →	7: 10.6x ↗		
3: 10.3 ↘	8: 10.8x ↑	Total	99
4: 10.5x ↗	9: 10.4 ↑		
5: 10.6x ↓	10: 9.5 ←		

11: 10.5x ↑	Serie	99
12: 10.3 →		
13: 10.6x ↗	Total	198
14: 10.5x ←		
15: 10.4 ↗		

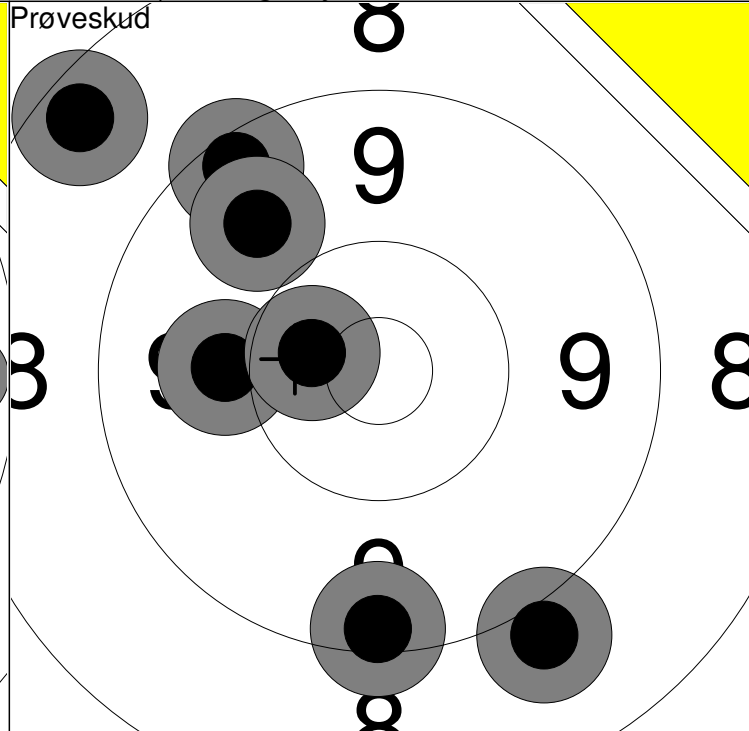
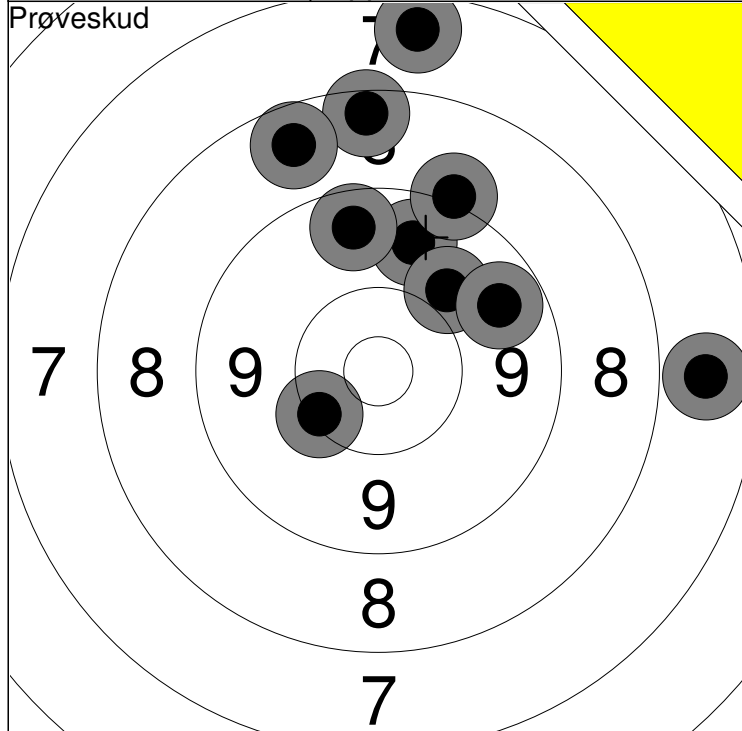

1: 7.7 →	6: 9.1 ↗	Serie	86
2: 9.7 ↑	7: 9.6 ↗		
3: 7.5 ↑	8: 8.4 ↑	Total	0
4: 10.0 ↗	9: 9.6 ↑		
5: 10.3 ↙	10: 8.6 ↗		

11: 9.0 ↘	16: 9.8 ↗	Serie	64
12: 10.0 ←	17: 10.5x ←		
13: 9.3 ↘		Total	0
14: 9.4 ↗			
15: 8.4 ↗			

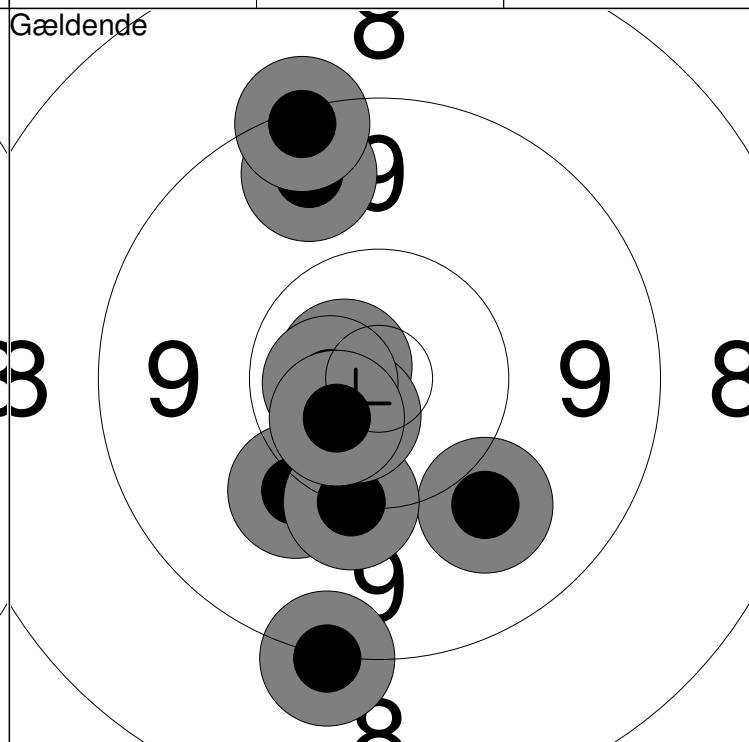
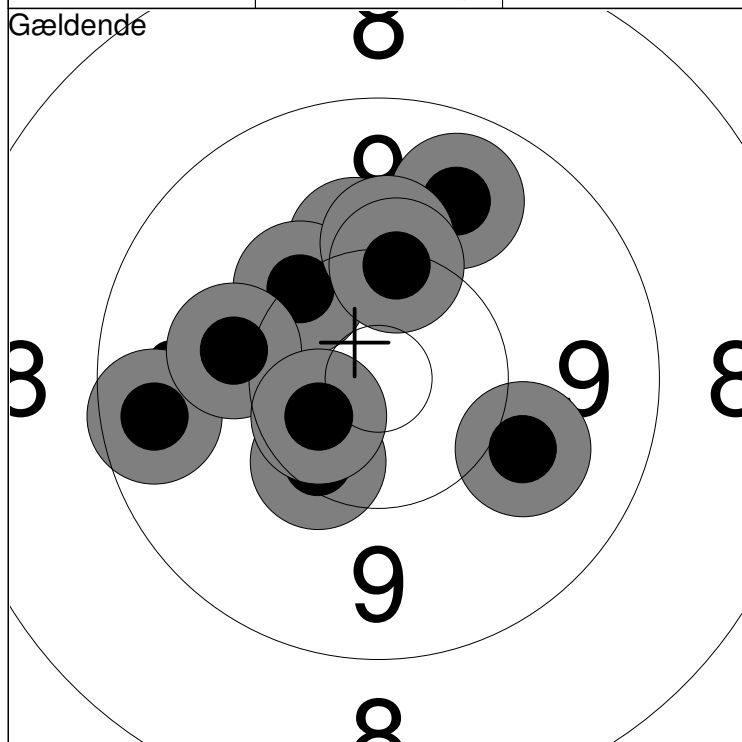

1: 9.5 ←	6: 10.1 ↑	Serie	98
2: 10.1 ↑	7: 10.2 ↑		
3: 9.7 ↗	8: 10.1 ←	Total	98
4: 10.2 ↗	9: 10.0 →		
5: 10.3 ↙	10: 10.5x ←		

11: 10.7x ←	16: 10.2 ↘	Serie	96
12: 9.6 ↗	17: 10.7x ↘		
13: 9.3 ↗	18: 10.6x ←	Total	194
14: 10.1 ↙	19: 9.2 ↘		
15: 9.9 ↘	20: 10.6x ↘		

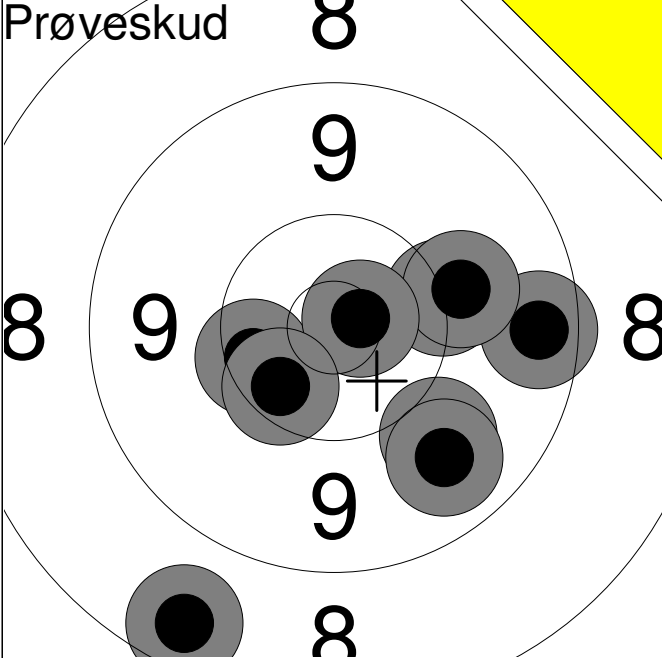
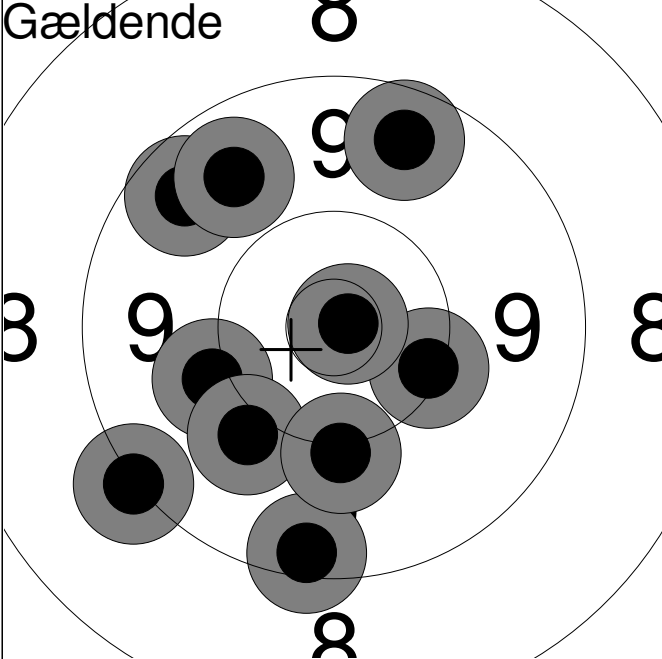
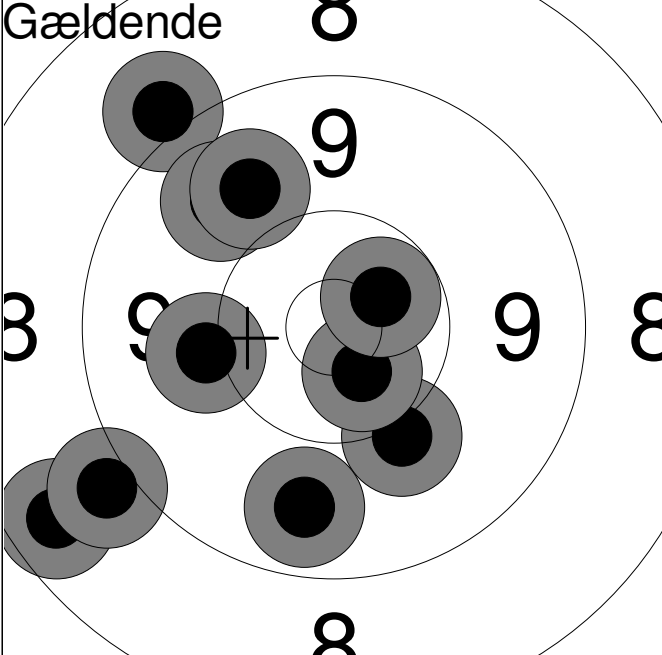
Hold	Skive	Trondur Hansen		
10	6			
50m	Aalborg Skyttekreds	MB3		
	Jeppestævne 2015	Aalborg Skyttekreds		
Prøveskud 	8	1:	9.9	↘
	9	2:	10.2	→
	8	3:	9.7	↘
	9	4:	9.5	→
	8	5:	10.0	→
	9	6:	8.5	↘
	8	7:	10.4	←
	9	8:	10.8x	→
	8	9:	10.4	↘
		Serie	85.0	
	Total	0.0		
Gældende 	8	1:	9.6	↗
	9	2:	9.6	↑
	8	3:	9.4	↘
	9	4:	10.0	←
	8	5:	10.2	→
	9	6:	10.0	↘
	8	7:	10.1	↘
	9	8:	9.2	↘
	8	9:	10.9x	→
		10:	9.7	↗
	Serie	95.0		
	Total	95.0		
Gældende 	8	11:	8.5	↙
	9	12:	9.0	↗
	8	13:	9.8	↗
	9	14:	10.1	↘
	8	15:	10.1	←
	9	16:	9.8	↗
	8	17:	9.0	↙
	9	18:	9.7	↘
	8	19:	10.6x	↘
		20:	10.6x	↗
	Serie	93.0		
	Total	188.0		

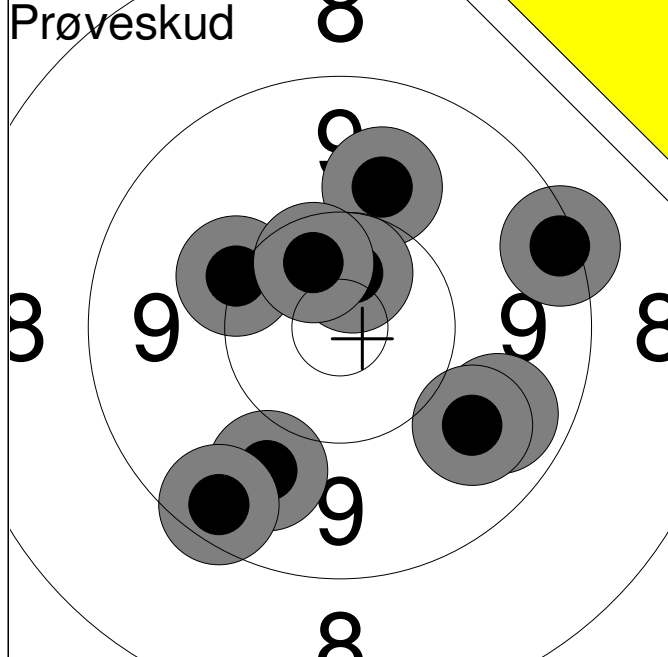

1:	9.9	↑
2:	9.7	→
3:	10.6x	↑
4:	9.3	→
5:	9.8	↘
6:	10.2	↗
7:	9.8	↘
8:	9.5	↘
9:	10.5x	↑

Serie	84.0
Total	0.0

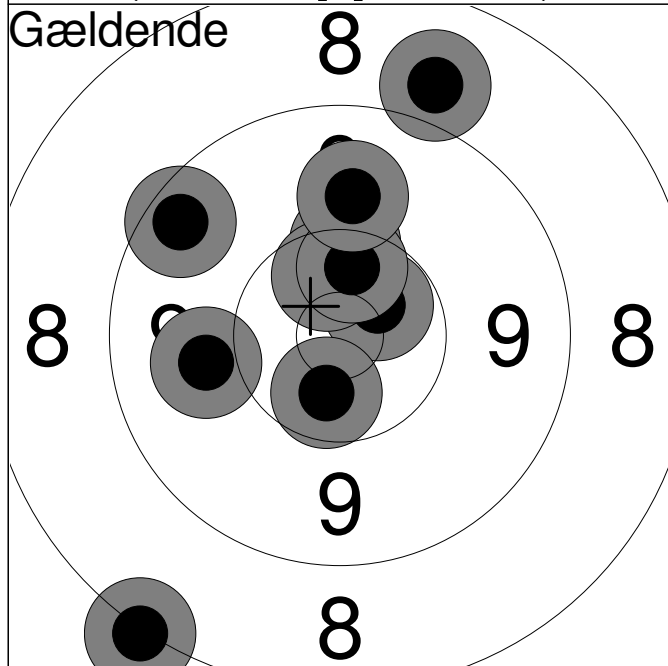

1:	10.6x	↗
2:	10.3	↑
3:	9.9	←
4:	10.5x	↑
5:	8.9	↑
6:	10.4x	↑
7:	9.5	↗
8:	10.5x	↘
9:	9.9	↑
10:	8.1	↘

Serie	93.0
Total	93.0

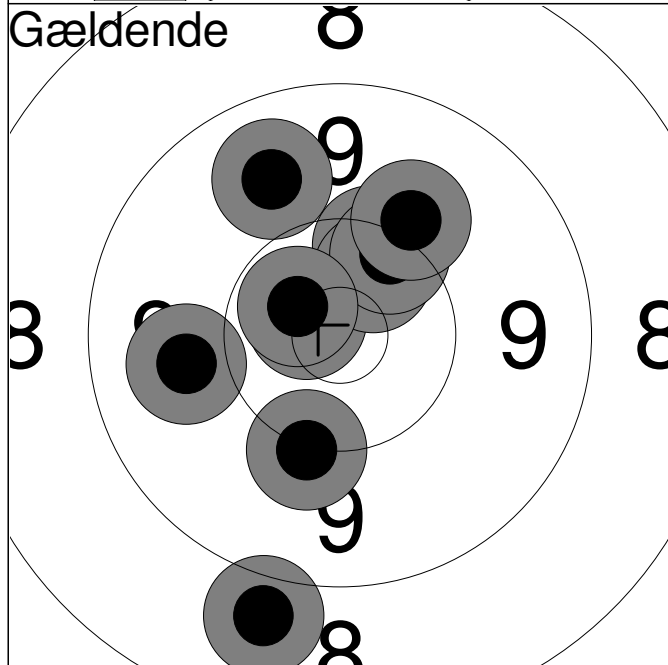

11:	10.7x	↖
12:	10.3	↑
13:	9.8	↑
14:	9.9	←
15:	10.5x	↑
16:	10.3	↗
17:	8.9	↘
18:	10.6x	↗
19:	10.1	↘
20:	10.0	↗

Serie	96.0
Total	189.0

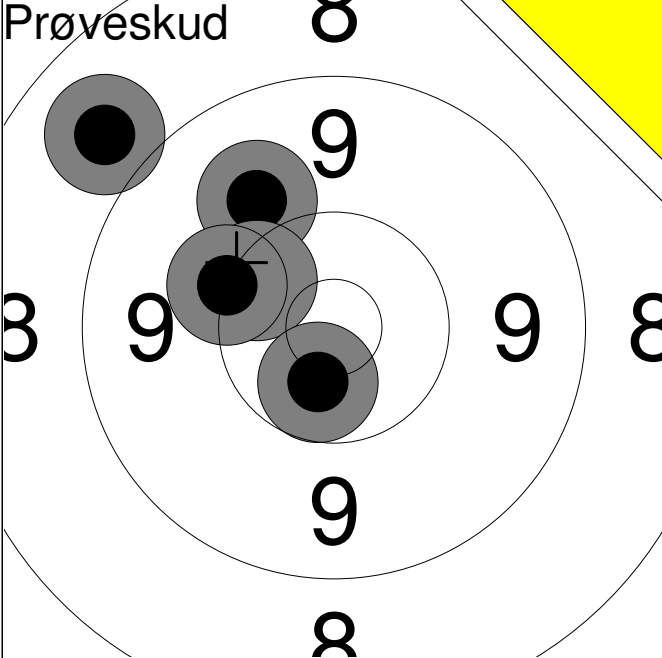
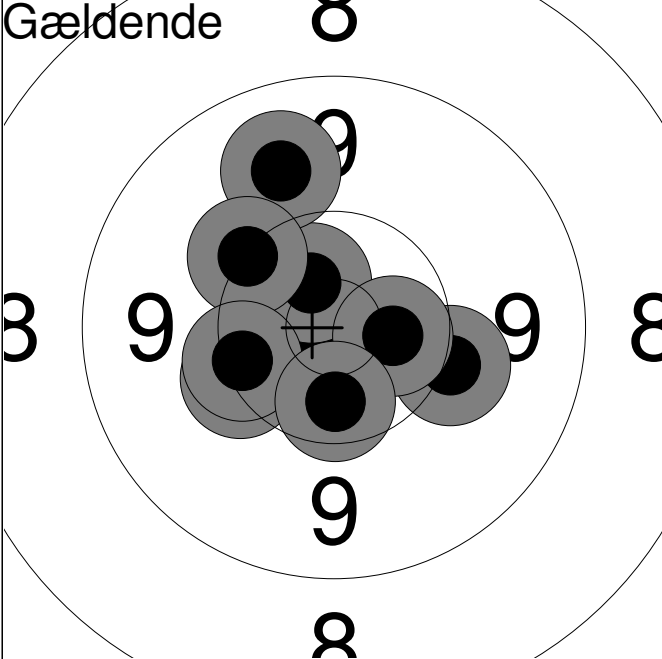
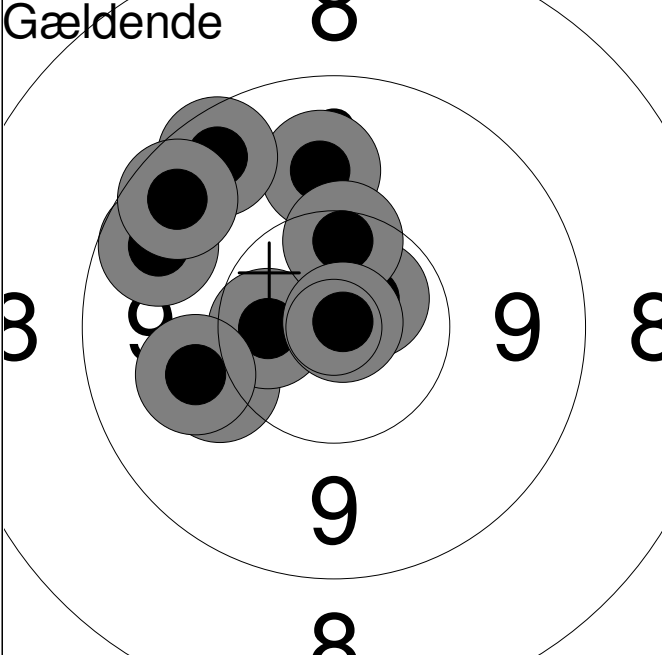
Hold	Skive	Karsten Abildgaard		
10	10	Hobro Egnens Skytteforening		MÅ1
50m		Jeppestævne 2015	Aalborg Skyttekreds	
Prøveskud		1:	8.8	↗
		2:	9.9	↗
		3:	10.3	↗
		4:	10.2	↗
		5:	10.6x	↘
		Serie		47.0
Total		0.0		
Gældende		1:	10.6x	←
		2:	10.7x	←
		3:	10.6x	↗
		4:	9.8	↗
		5:	10.1	→
		6:	10.2	←
		7:	10.2	↗
		8:	10.3	←
		9:	10.5x	→
		10:	10.4x	↓
		Serie		99.0
Total		99.0		
Gældende		11:	10.1	←
		12:	9.9	↑
		13:	9.5	↗
		14:	9.6	↗
		15:	10.6x	↗
		16:	10.5x	←
		17:	10.4	↑
		18:	9.5	↗
		19:	10.9x	↗
		20:	10.0	←
		Serie		96.0
Total		195.0		

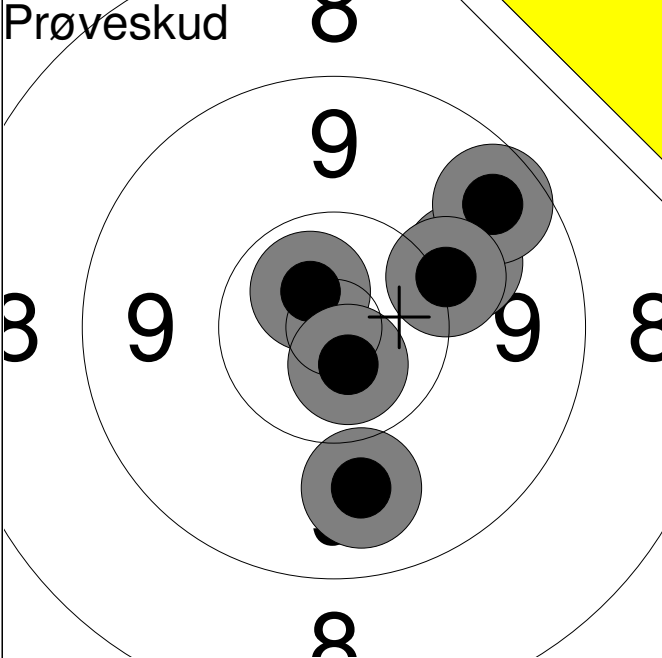
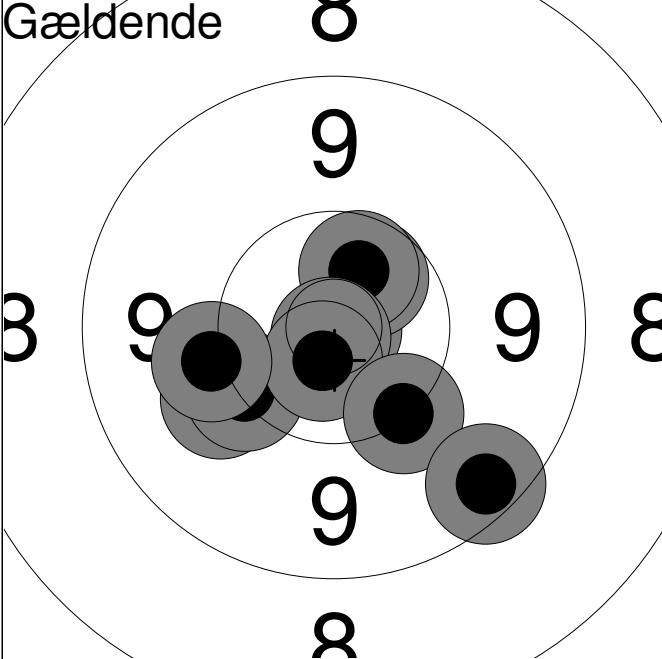
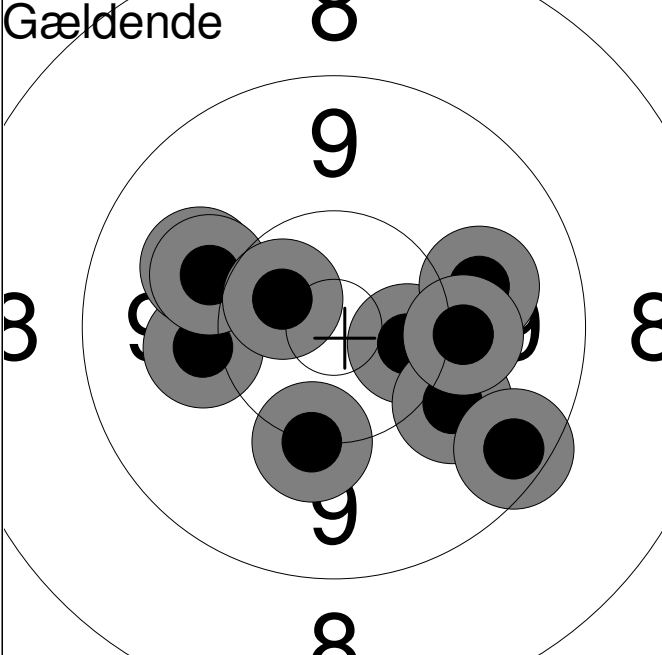
Hold	Skive	Daniel Mørk	
11	1		
50m	Hobro Egnens Skytteforening		MÅ1
Jeppestævne 2015		Aalborg Skyttekreds	
Prøveskud		1: 10.0 →	
		2: 10.7x ↗	
		3: 9.8 ↓	
		4: 9.5 ↗	
		5: 10.1 ↗	
		6: 10.7x ↓	
		Serie	58.0
		Total	0.0
Gældende		1: 10.0 ←	
		2: 10.9x →	
		3: 10.5x ↗	
		4: 10.2 ←	
		5: 10.5x ↗	
		6: 10.9x ↓	
		7: 10.7x ↓	
		8: 10.1 ←	
		9: 10.2 ↓	
		10: 9.4 ↓	
		Serie	99.0
		Total	99.0
Gældende		11: 10.0 ←	
		12: 10.4x →	
		13: 10.2 ↓	
		14: 10.0 ↓	
		15: 9.4 ↓	
		16: 10.0 ↗	
		17: 10.0 ↗	
		18: 9.9 →	
		19: 10.1 →	
		20: 10.5x ↗	
		Serie	98.0
		Total	197.0

Hold	Skive	Christine Langbak Poulsen	
11	4		

50m	Hobro Egnens Skytteforening	BK2	
-----	-----------------------------	-----	--

	Jeppestævne 2015	Aalborg Skyttekreds	
--	------------------	---------------------	--

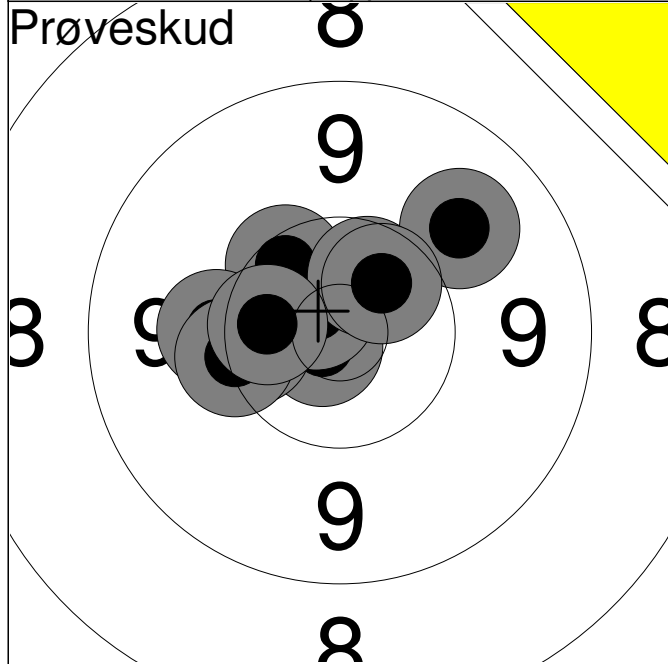

1:	9.9	↗
2:	10.8x	↖
3:	10.7x	↗
4:	10.3	↖
5:	10.4	↗
6:	10.5x	↗
7:	10.1	↖
8:	10.5x	↗
9:	10.2	↖
10:	10.4x	↖
Serie		99.0
Total		0.0

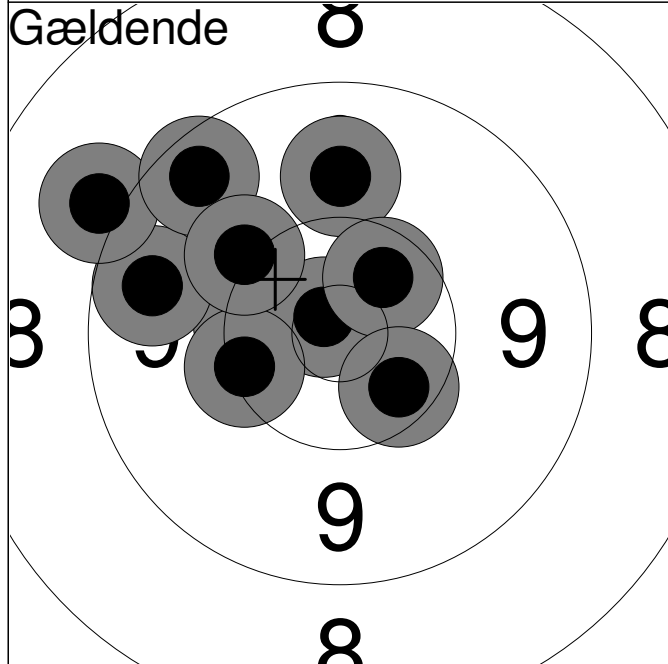

1:	10.4	↖
2:	9.9	↑
3:	10.8x	↗
4:	9.6	↖
5:	9.0	↗
6:	9.5	↗
7:	10.3	↖
8:	10.1	↗
9:	10.5x	↗
10:	10.4	↘
Serie		96.0
Total		96.0

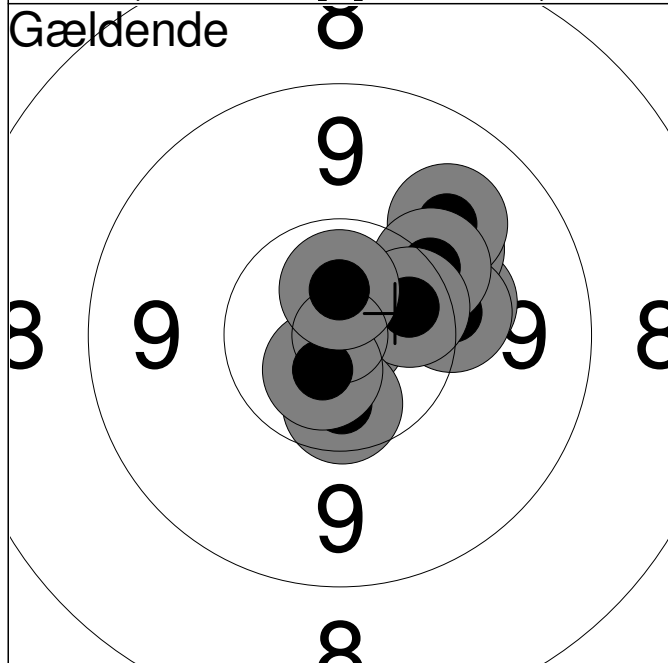

11:	10.9x	→
12:	10.1	→
13:	10.0	↗
14:	9.9	↗
15:	10.2	→
16:	10.2	↗
17:	10.4x	→
18:	10.5x	↓
19:	10.7x	↖
20:	10.6x	↑
Serie		99.0
Total		195.0

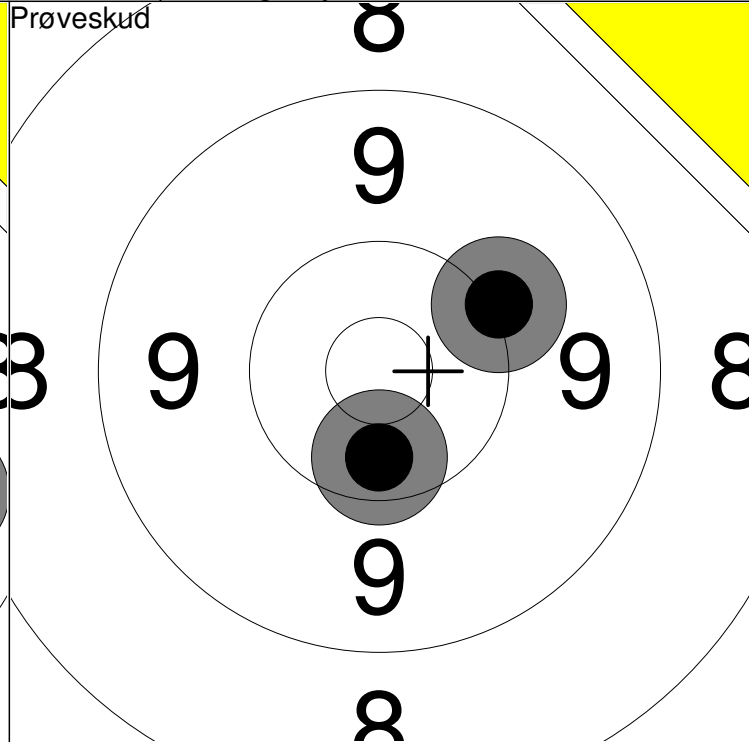
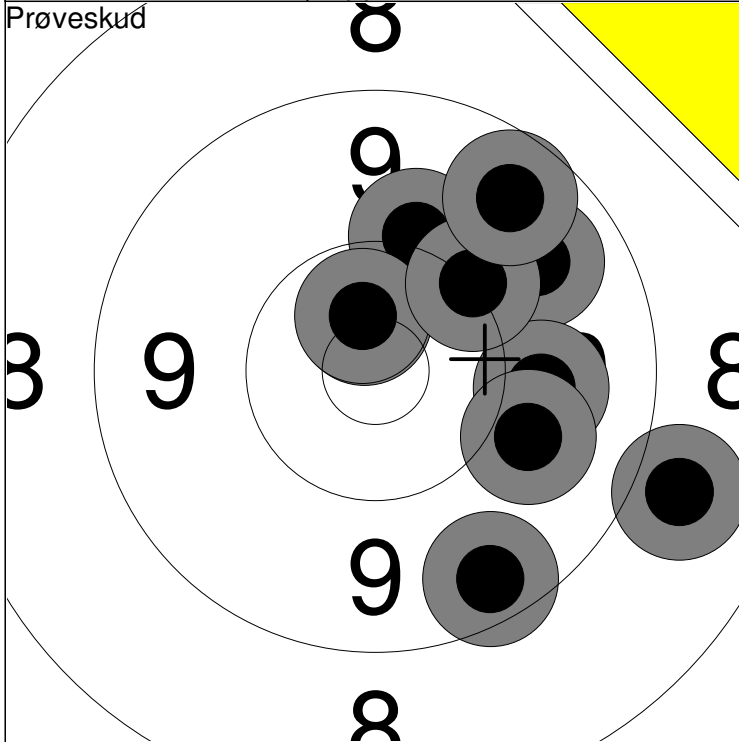

1: 10.6x ↑	6: 9.5 ↓	Serie	93
2: 9.8 ↗	7: 10.6x ↑		
3: 9.9 →	8: 9.9 →	Total	0
4: 8.9 →	9: 10.1 ↗		
5: 10.1 ↑	10: 9.6 ↗		

11: 10.1 ↗	Serie	20
12: 10.4x ↓		
Total		0

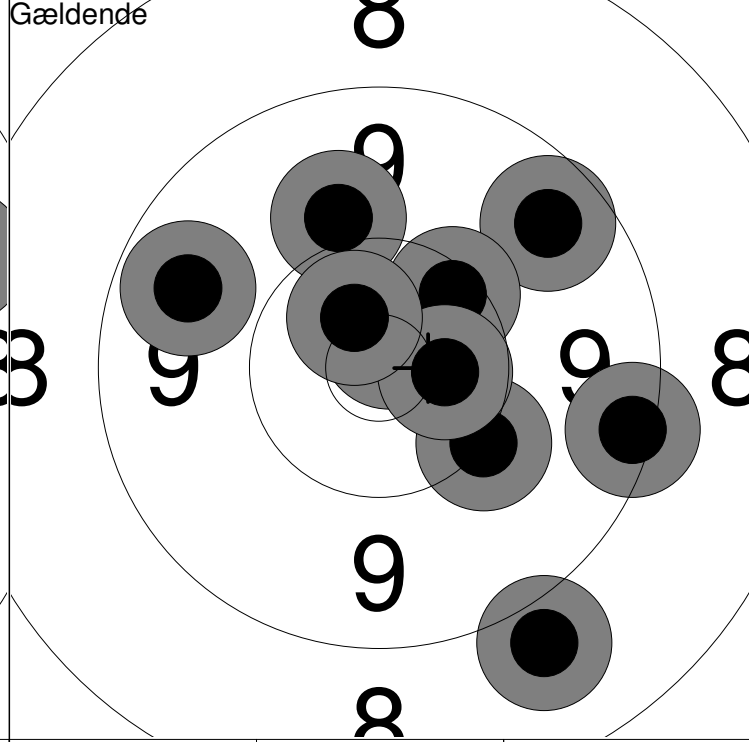
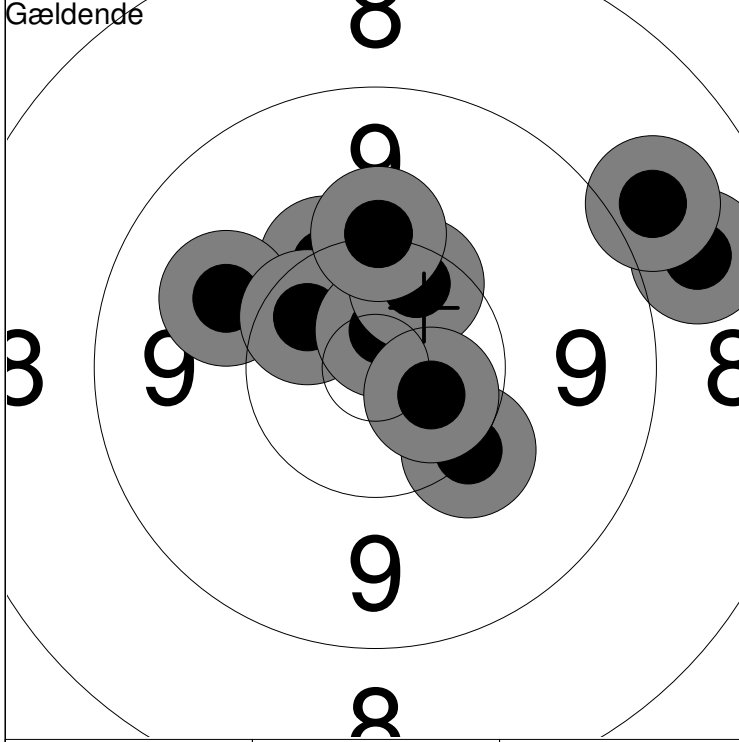

1: 10.2 ↑	6: 10.4 ↑	Serie	95
2: 9.9 ↖	7: 8.8 →		
3: 10.2 ↓	8: 10.1 ↑	Total	95
4: 10.4x ↖	9: 8.9 ↗		
5: 10.7x ↑	10: 10.6x ↘		

11: 10.2 ↓	Serie	95
12: 10.8x ↑		
13: 9.3 →	Total	190
14: 9.6 ↗		
15: 8.9 ↓		

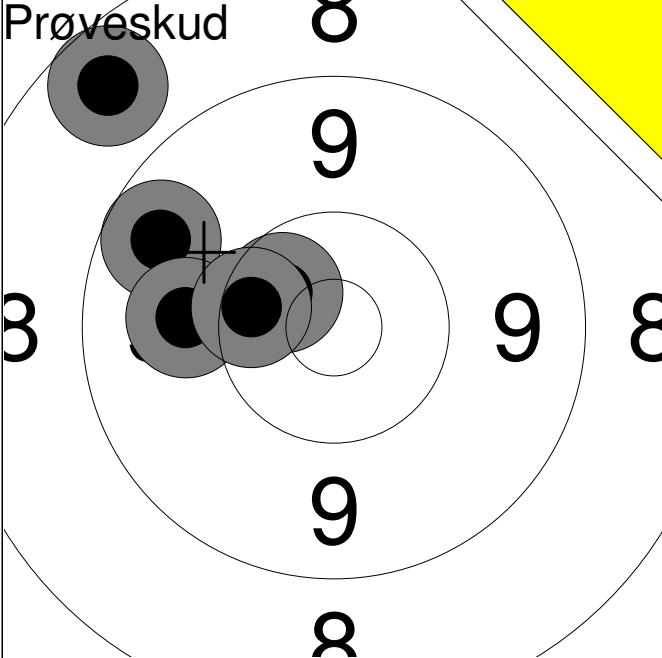
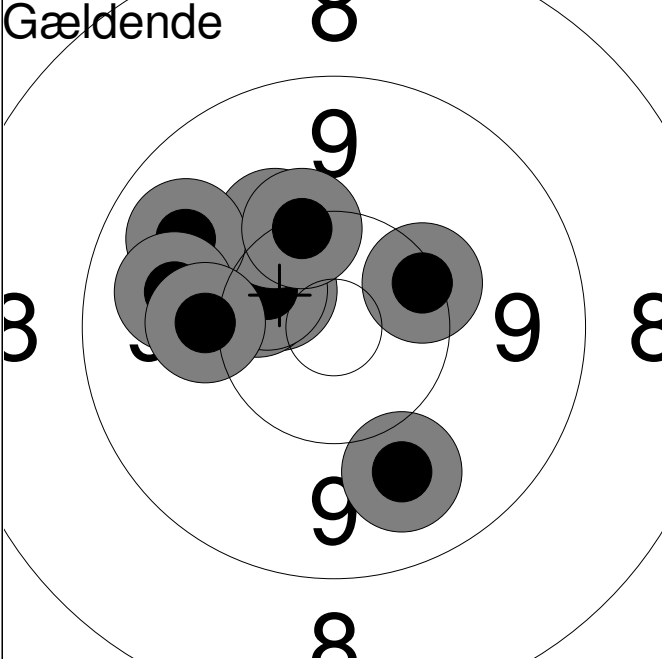
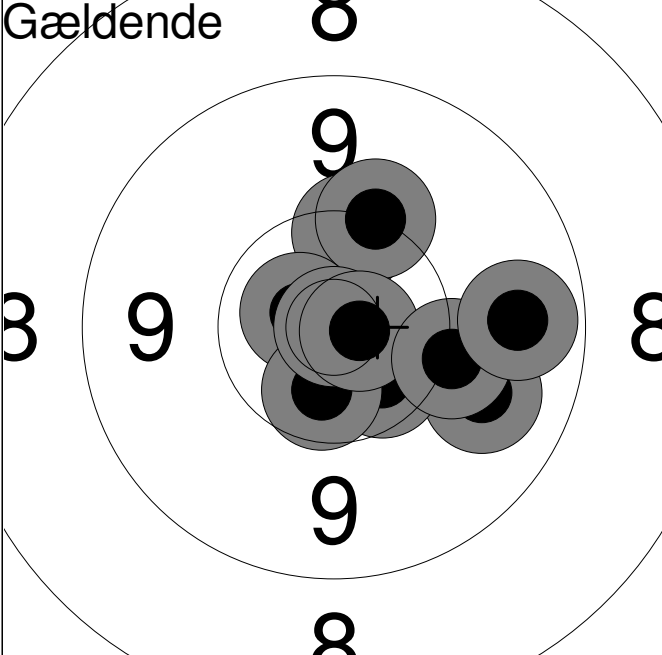
Hold	Skive	Anders Hansen	
11	9		
50m	Aalborg Skyttekreds	ÅK1	
	Jeppestævne 2015	Aalborg Skyttekreds	
Prøveskud 	1:	9.6	↗
	2:	8.6	↗
	3:	9.9	←
	4:	10.5x	↗
	5:	10.4	↗
Serie		46.0	
Total		0.0	
Gældende 	1:	10.5x	↗
	2:	10.4	↗
	3:	10.4x	↗
	4:	10.2	↗
	5:	9.8	↗
	6:	10.2	↗
	7:	9.8	←
	8:	10.1	←
	9:	9.9	↘
	10:	10.3	↗
Serie		97.0	
Total		97.0	
Gældende 	11:	9.8	↘
	12:	10.3	↗
	13:	10.2	↗
	14:	10.7x	↗
	15:	10.5x	↘
	16:	10.5x	↘
	17:	10.9x	↗
	18:	10.8x	→
	19:	10.1	↘
	20:	9.7	→
Serie		98.0	
Total		195.0	

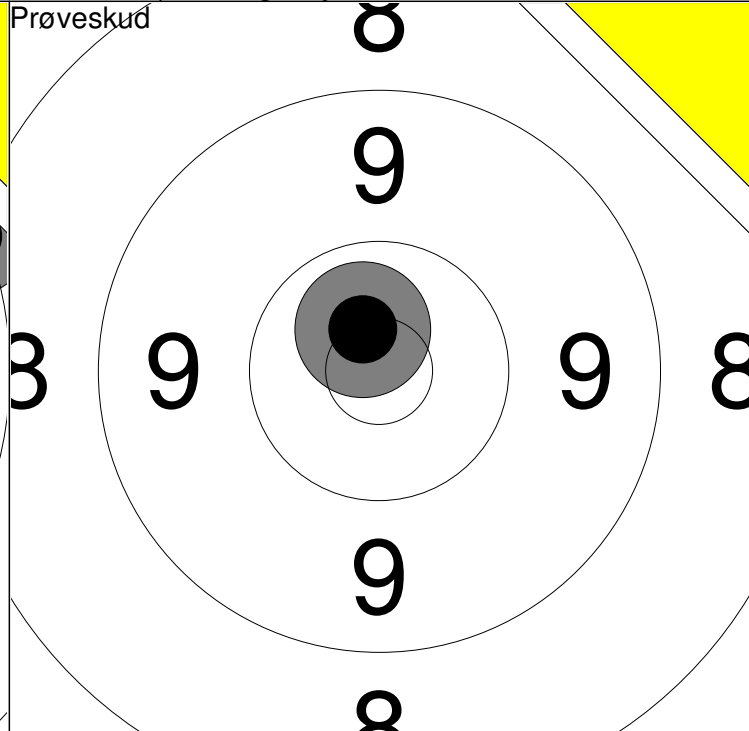
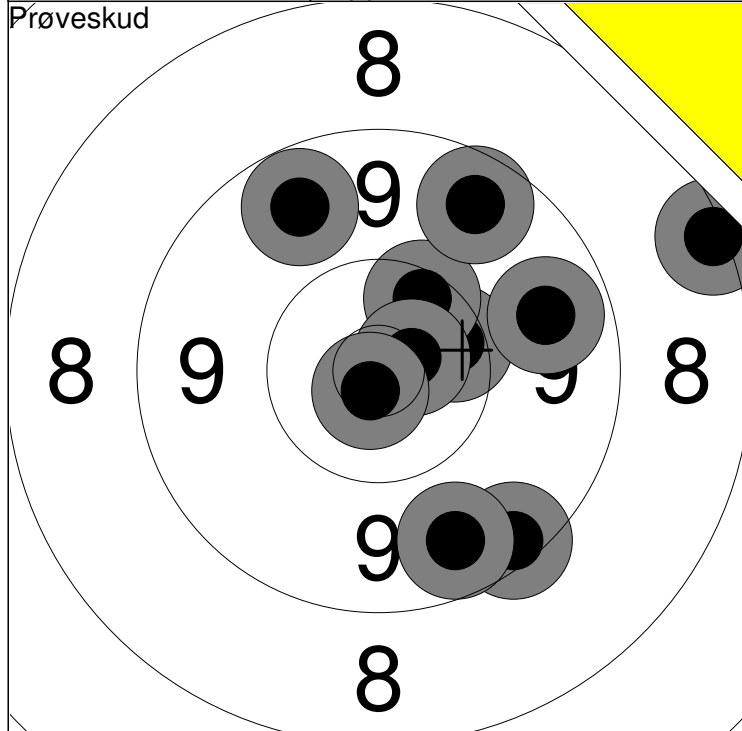

1: 9.6 ↗	6: 10.3 ↗	Serie	93
2: 10.4 →	7: 9.6 ↗		
3: 8.3 →	8: 10.7x →	Total	0
4: 9.7 →	9: 10.8x ↓		
5: 9.4 ↓	10: 9.6 ↓		

11: 10.7x ↗	Serie	10
	Total	0

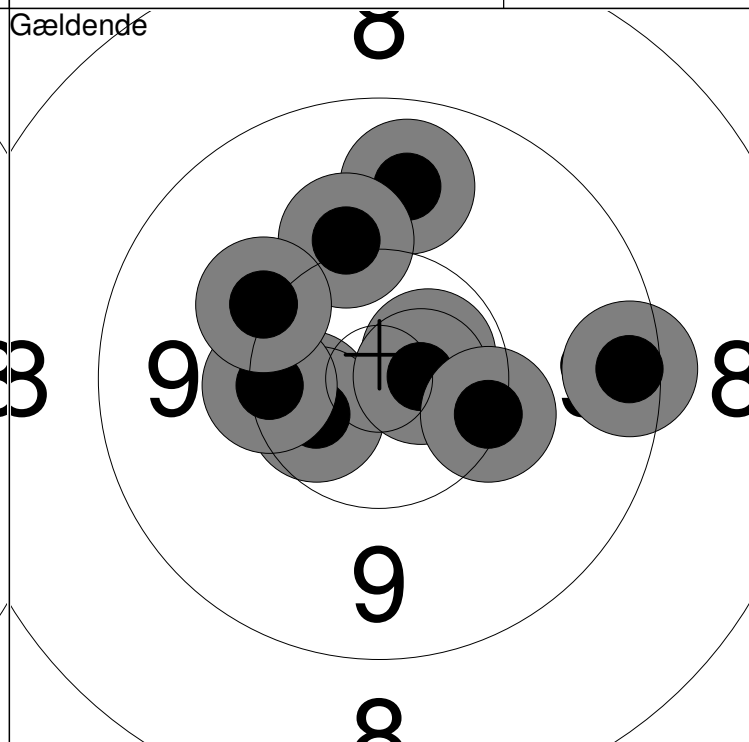
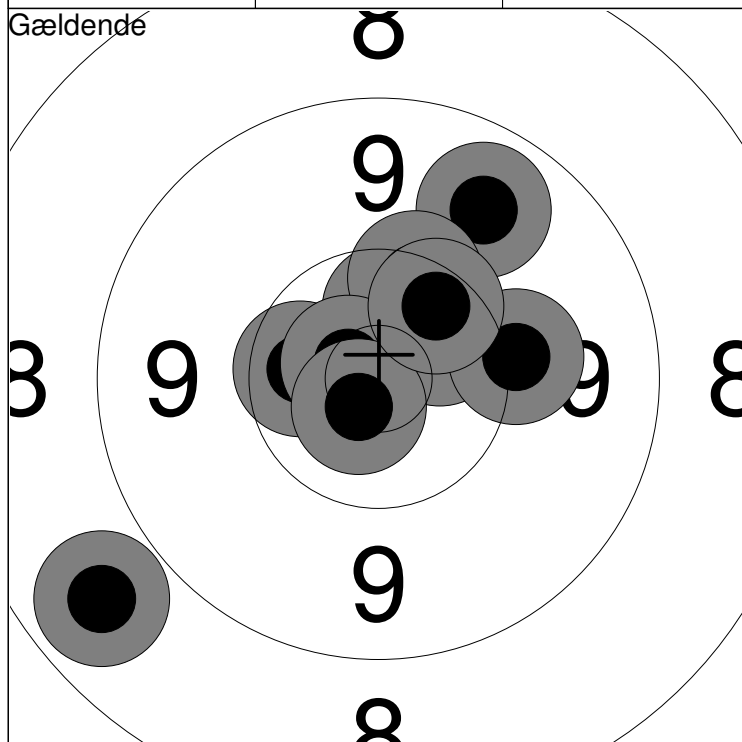

1: 10.5x ↑	6: 10.3 ↗	Serie	97
2: 10.5x ←	7: 10.7x ↖		
3: 10.5x ↗	8: 10.7x ↓	Total	97
4: 9.7 ↗	9: 8.7 ↖		
5: 10.1 →	10: 10.4 ↗		

11: 10.6x →	16: 10.1 ↑	Serie	98
12: 9.4 →	17: 10.3 ←		
13: 9.8 ↑	18: 10.1 ↖	Total	195
14: 10.5x ←	19: 10.7x →		
15: 10.5x ↖	20: 10.2 →		

Hold 12	Skive 4	Christine Langbak Poulsen	
-------------------	-------------------	----------------------------------	--

50m	Hobro Egnens Skytteforening	MB2	
-----	-----------------------------	-----	--

	Jeppestævne 2015	Aalborg Skyttekreds	
--	------------------	---------------------	--

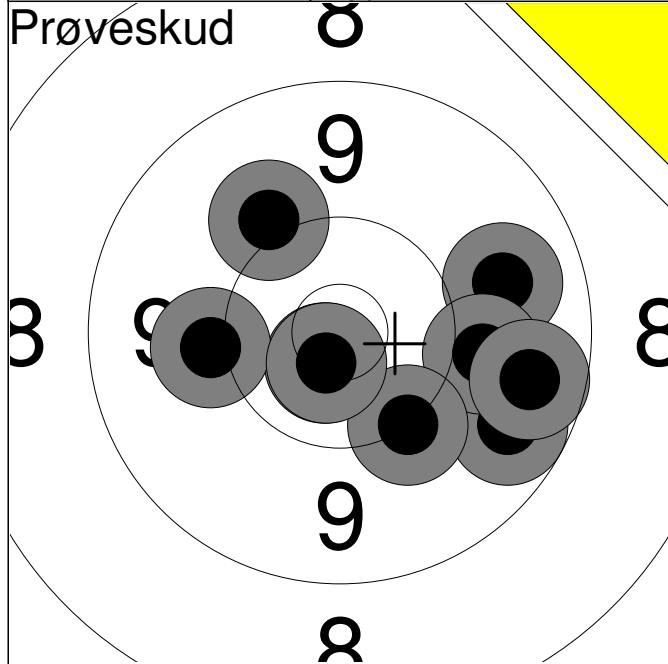

1:	9.6	↘
2:	9.8	→
3:	10.0	→
4:	9.6	→
5:	10.7x	↘
6:	10.1	←
7:	10.2	↘
8:	10.7x	↘
9:	10.0	↗

Serie	87.0
Total	0.0

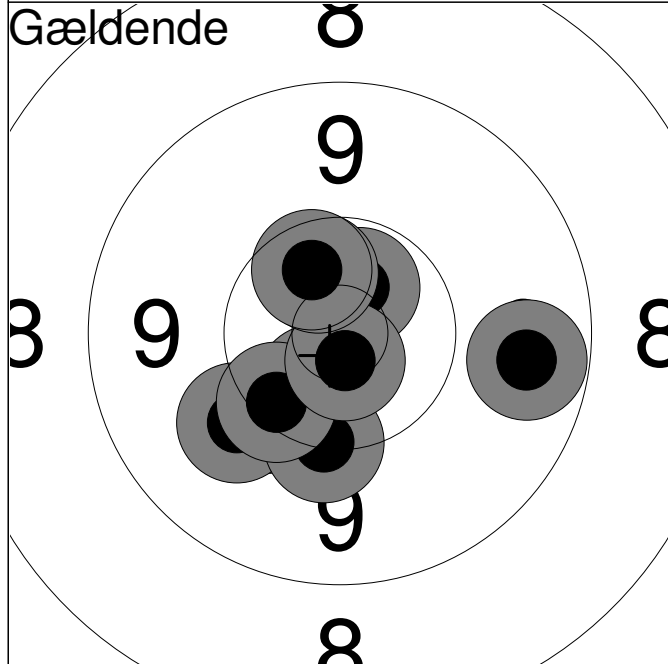

1:	9.6	→
2:	10.6x	↘
3:	10.2	↘
4:	10.0	↘
5:	10.2	↘
6:	10.3	↘
7:	10.6x	↗
8:	10.8x	↘
9:	10.5x	↗
10:	10.5x	↗

Serie	99.0
Total	99.0

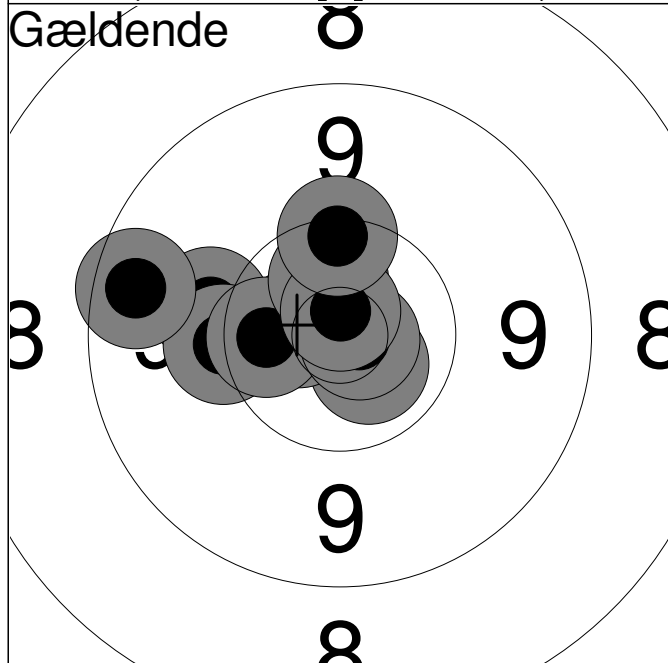

11:	10.0	←
12:	10.7x	↘
13:	10.7x	←
14:	10.2	←
15:	10.4x	←
16:	10.8x	→
17:	10.6x	↗
18:	10.8x	↗
19:	9.5	←
20:	10.3	↗

Serie	99.0
Total	198.0

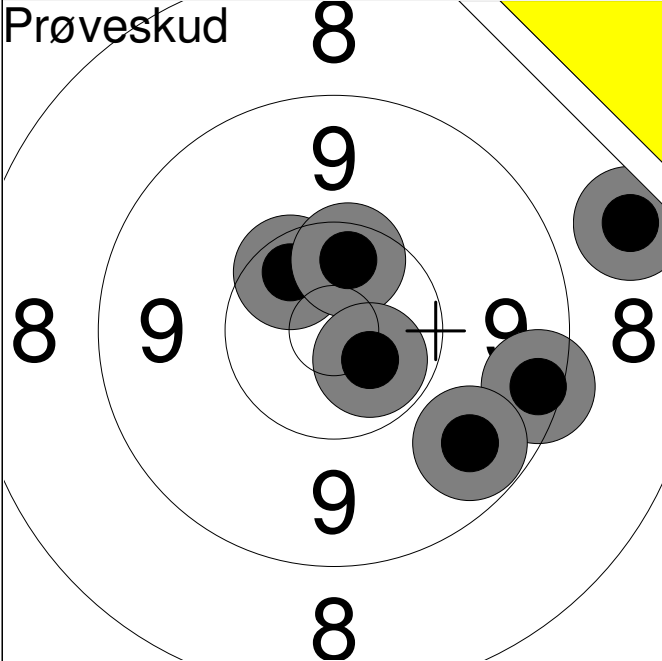
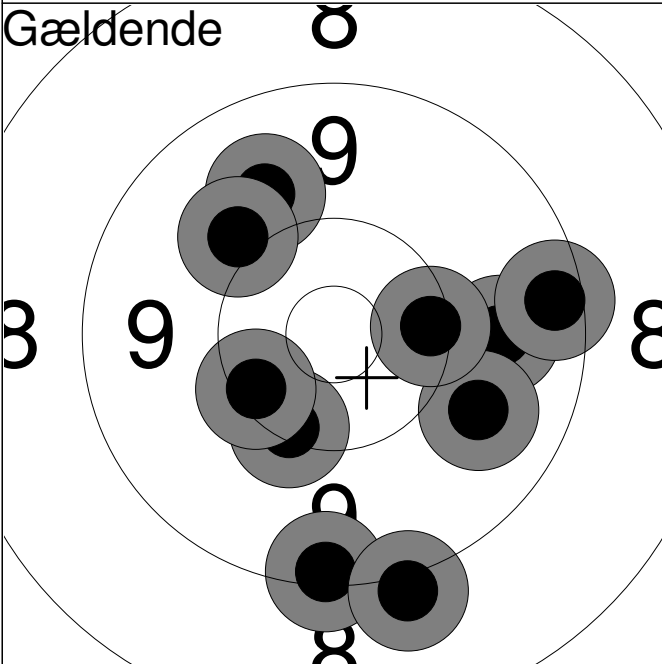
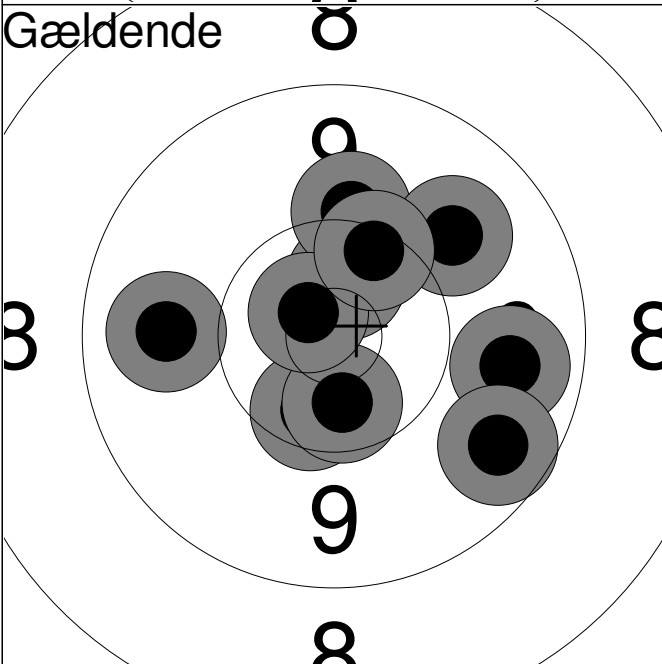
Hold	Skive	Bodil Abildgaard	
12	5		
50m	Hobro Egnens Skytteforening	MÅ1	
	Jeppestævne 2015	Aalborg Skyttekreds	
Prøveskud 	1:	8.5	→
	2:	10.4x	↗
	3:	9.4	→
	4:	9.6	↘
	5:	10.4x	↑
	6:	10.6x	↘
	Serie	56.0	
Total	0.0		
Gældende 	1:	9.3	↓
	2:	9.8	→
	3:	9.9	↗
	4:	9.1	↘
	5:	9.8	↘
	6:	10.2	↘
	7:	10.3	↖
	8:	10.0	↗
	9:	9.4	→
	10:	10.3	→
Serie	94.0		
Total	94.0		
Gældende 	11:	10.6x	↑
	12:	10.1	↑
	13:	10.4x	↘
	14:	9.9	↗
	15:	9.8	←
	16:	9.7	→
	17:	9.6	↘
	18:	10.5x	↘
	19:	10.7x	↗
	20:	10.3	↑
Serie	96.0		
Total	190.0		

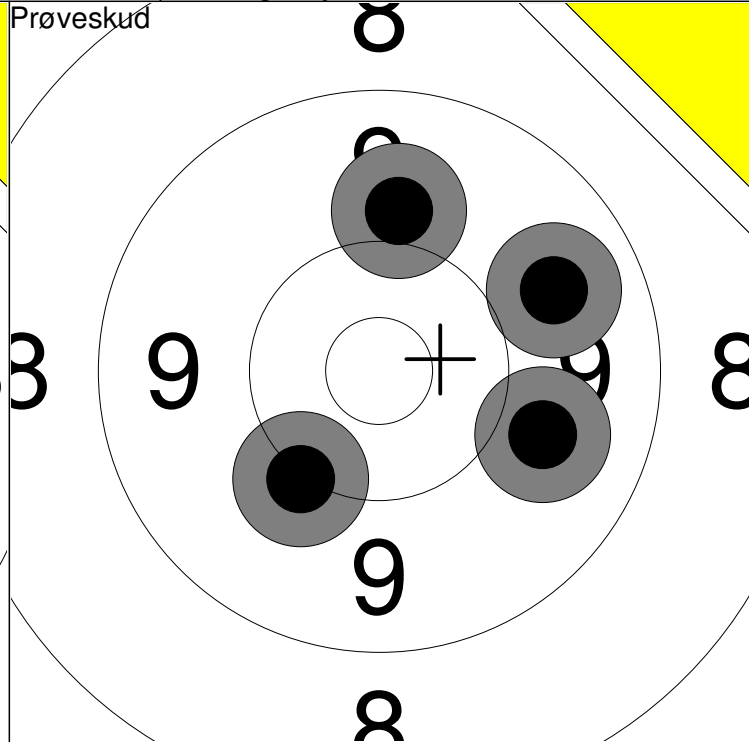
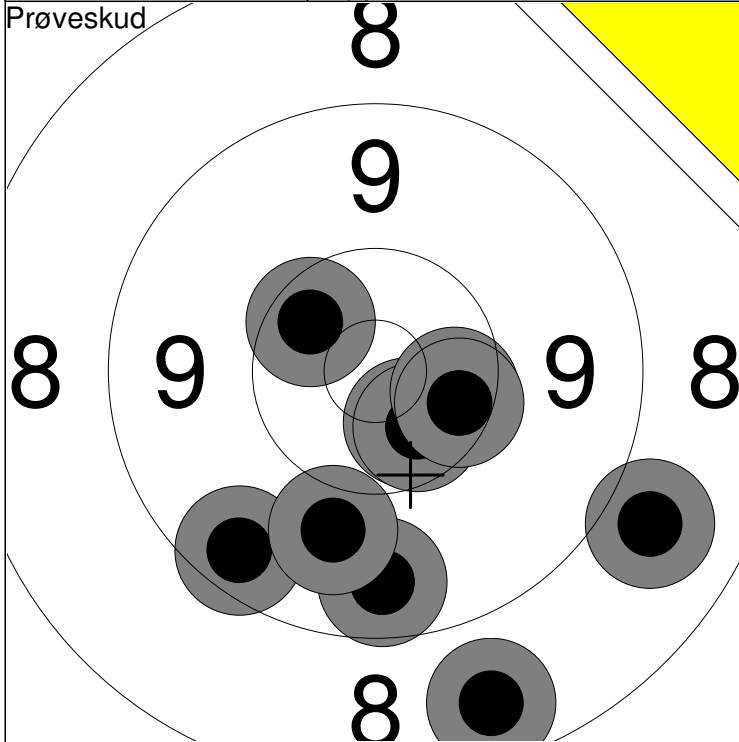

1: 10.6x ↓	6: 8.6 ↓	Serie	93
2: 10.5x ↓	7: 9.5 ↓		
3: 8.8 ↓	8: 10.4 →	Total	0
4: 10.4x →	9: 10.4x ↗		
5: 9.6 ↓	10: 9.9 ↓		

11: 9.8 →	Serie	38
12: 9.9 →		
13: 10.0 ↑	Total	0
14: 10.1 ↓		

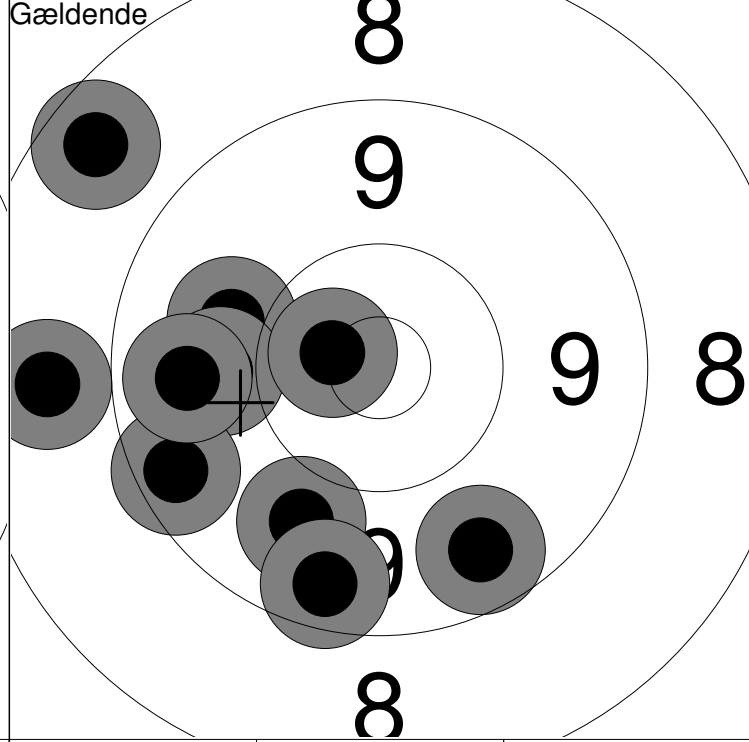
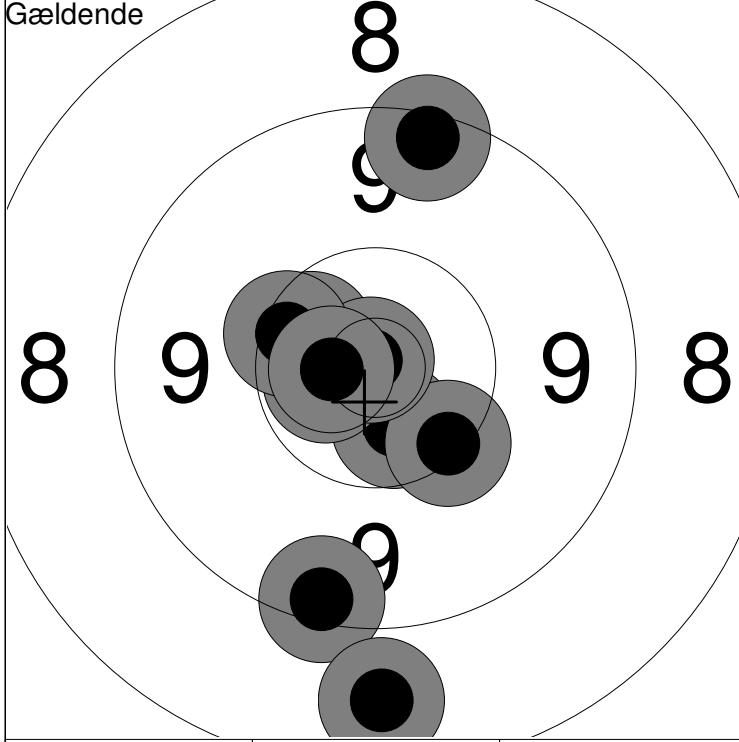

1: 10.6x ↓	6: 10.6x ←	Serie	96
2: 9.3 ↓	7: 10.9x ↗		
3: 10.3 ↓	8: 8.7 ↓	Total	96
4: 10.5x ↗	9: 10.3 ←		
5: 9.4 ↑	10: 10.7x ←		

11: 10.0 ←	Serie	90
12: 9.9 ←		
13: 9.8 ↓	Total	186
14: 8.5 ↗		
15: 9.5 ←	16: 9.6 ↓	
	17: 9.5 ↓	
	18: 8.7 ←	
	19: 10.6x ←	
	20: 9.7 ←	

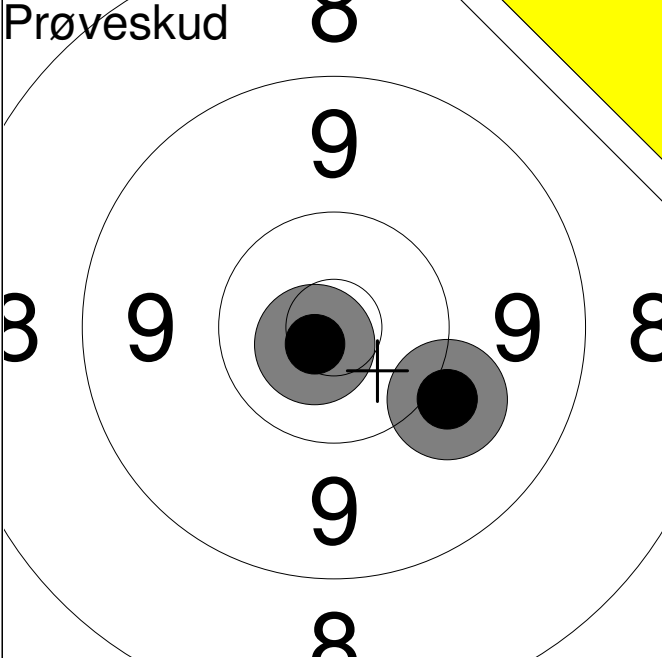
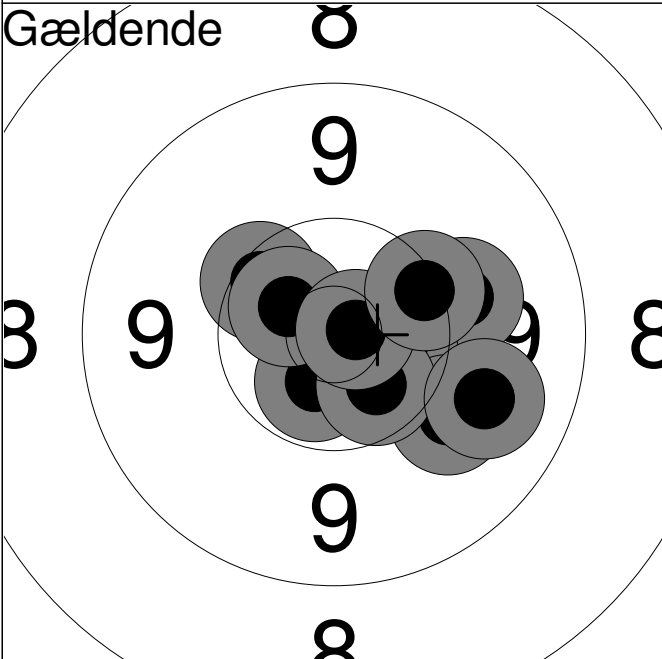
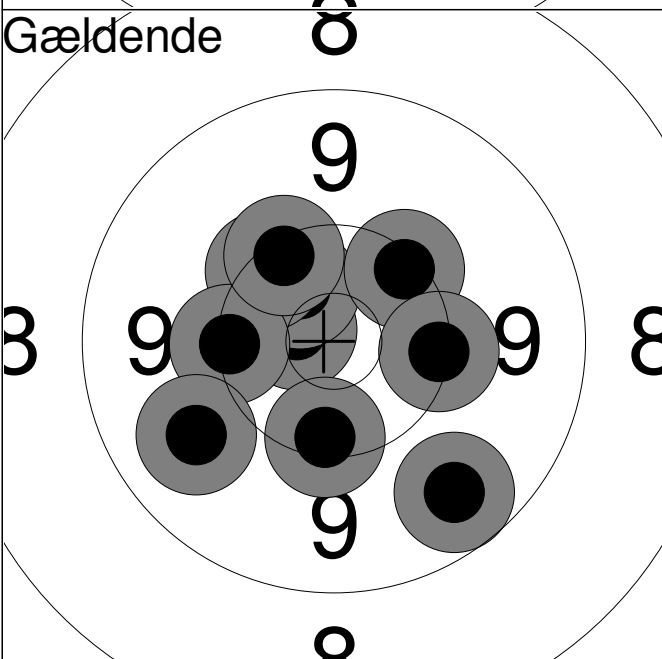
Hold	Skive	Anders Hansen	
12	9		
50m	Aalborg Skyttekreds	MÅ1	
	Jeppestævne 2015	Aalborg Skyttekreds	
Prøveskud		1: 10.8x	↙
		2: 10.0	↘
		Serie 20.0	
		Total 0.0	
Gældende		1: 10.0	→
		2: 10.3	↗
		3: 10.6x	↙
		4: 10.5x	→
		5: 10.0	↘
		6: 10.6x	↗
		7: 10.5x	↙
		8: 9.8	↘
		9: 10.8x	→
		10: 10.3	↗
		Serie 99.0	
		Total 99.0	
Gældende		11: 10.7x	↖
		12: 10.5x	↗
		13: 10.3	↗
		14: 10.3	↗
		15: 10.2	↖
		16: 9.8	↙
		17: 10.3	↗
		18: 10.2	→
		19: 9.6	↘
		20: 10.3	↘
		Serie 98.0	
		Total 197.0	

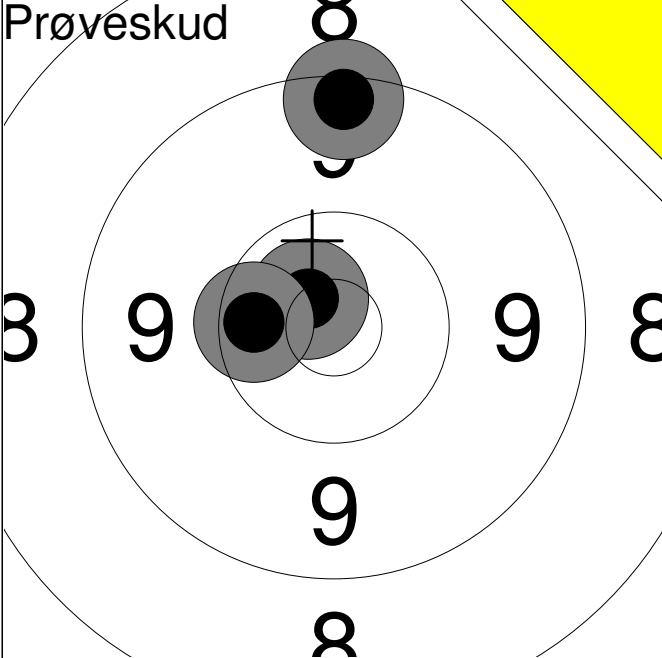
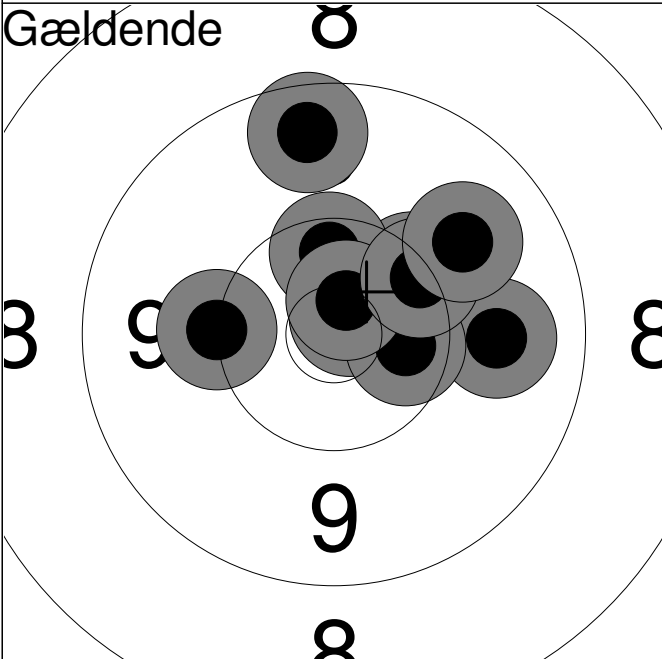
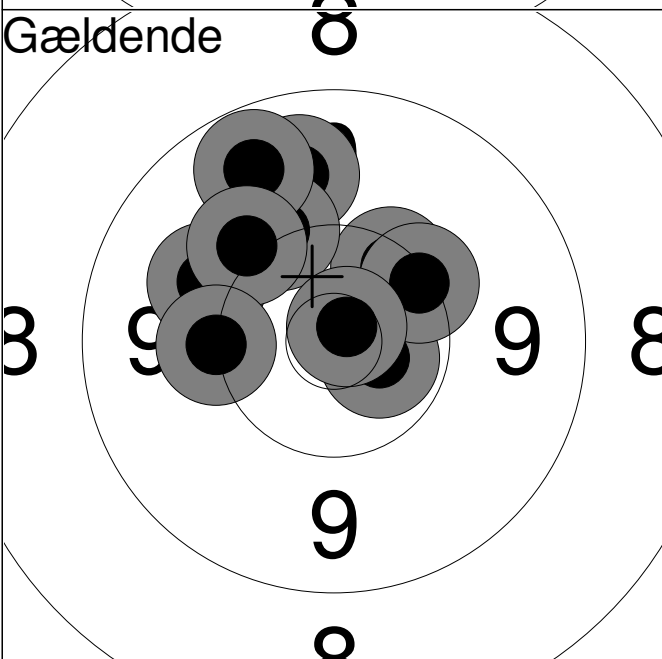
Hold	Skive	Jens Arne Abildgaard		
12	10	Hobro Egnens Skytteforening		MÅ1
50m		Jeppestævne 2015	Aalborg Skyttekreds	
Prøveskud		1:	9.3	↑
		2:	10.7x	↗
		3:	10.4	←
		Serie		29.0
Total		0.0		
Gældende		1:	10.8x	↗
		2:	9.8	→
		3:	10.3	↗
		4:	10.4	↑
		5:	10.5x	→
		6:	9.5	↑
		7:	10.1	←
		8:	10.7x	↑
		9:	10.2	↗
		10:	9.9	↗
		Serie		97.0
Total		97.0		
Gældende		11:	9.8	↑
		12:	10.0	↖
		13:	10.3	↗
		14:	10.6x	→
		15:	10.1	↗
		16:	10.2	↗
		17:	10.8x	↗
		18:	9.6	↑
		19:	10.1	↗
		20:	10.1	←
		Serie		98.0
Total		195.0		

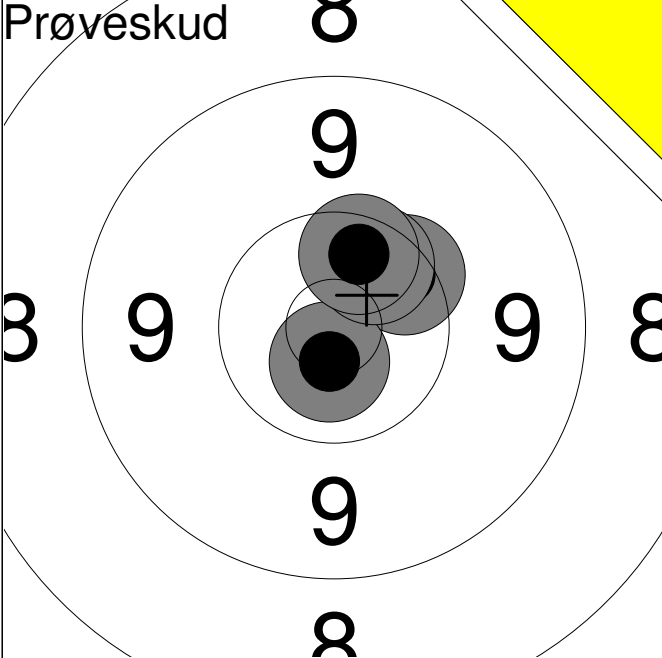
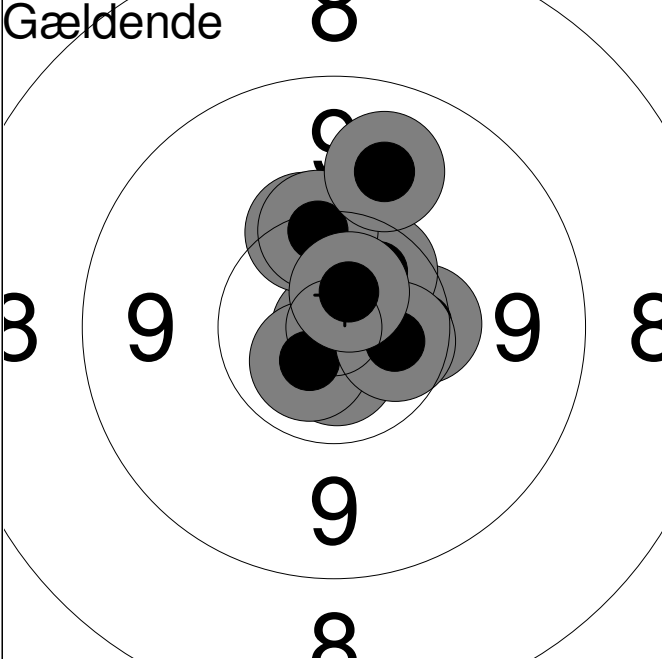
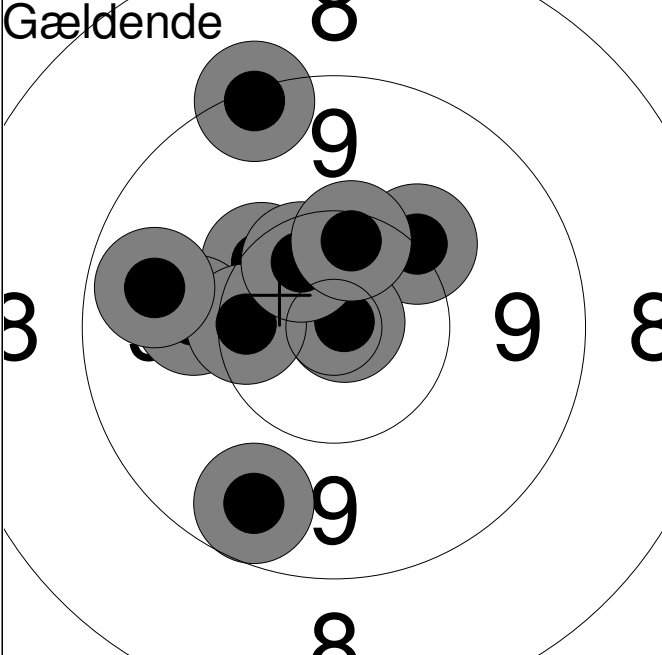
Hold	Skive	Jørgen Thomsen		
14	1	Hobro Egnens Skytteforening		ÅK1
50m		Jeppestævne 2015	Aalborg Skyttekreds	
Prøveskud		1:	10.3	↗
		2:	10.7x	↓
		3:	10.4x	↗
		4:	10.4x	↗
		Serie	40.0	
Total	0.0			
Gældende		1:	10.3	→
		2:	10.5x	↗
		3:	10.7x	↓
		4:	10.9x	↙
		5:	10.7x	↙
		6:	10.3	↑
		7:	10.3	↑
		8:	10.5x	→
		9:	9.8	↑
		10:	10.7x	↗
		Serie	99.0	
Total	99.0			
Gældende		11:	10.3	↖
		12:	10.1	↗
		13:	10.0	←
		14:	9.3	↑
		15:	10.9x	↗
		16:	10.4	←
		17:	9.7	←
		18:	9.6	↙
		19:	10.5x	↗
		20:	10.4	↑
		Serie	97.0	
Total	196.0			

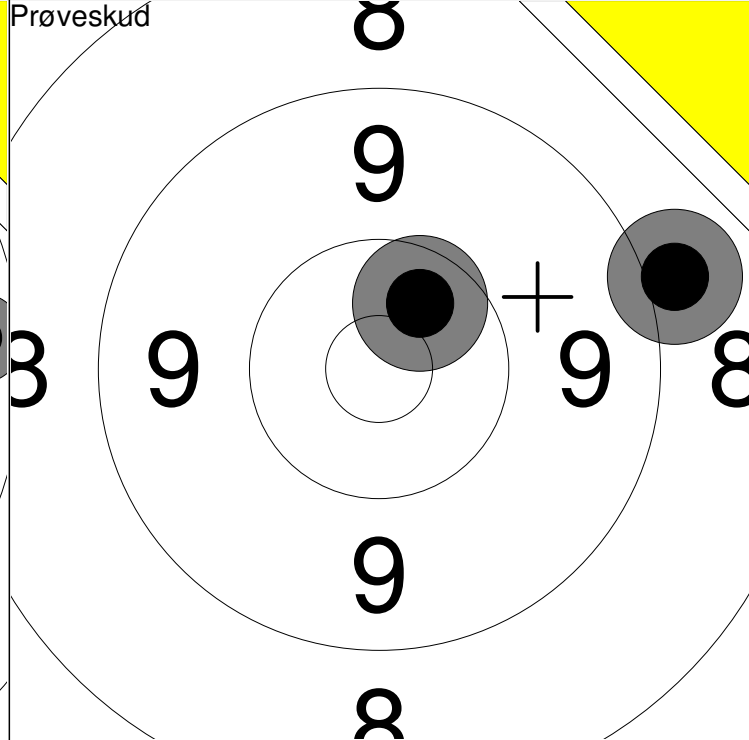
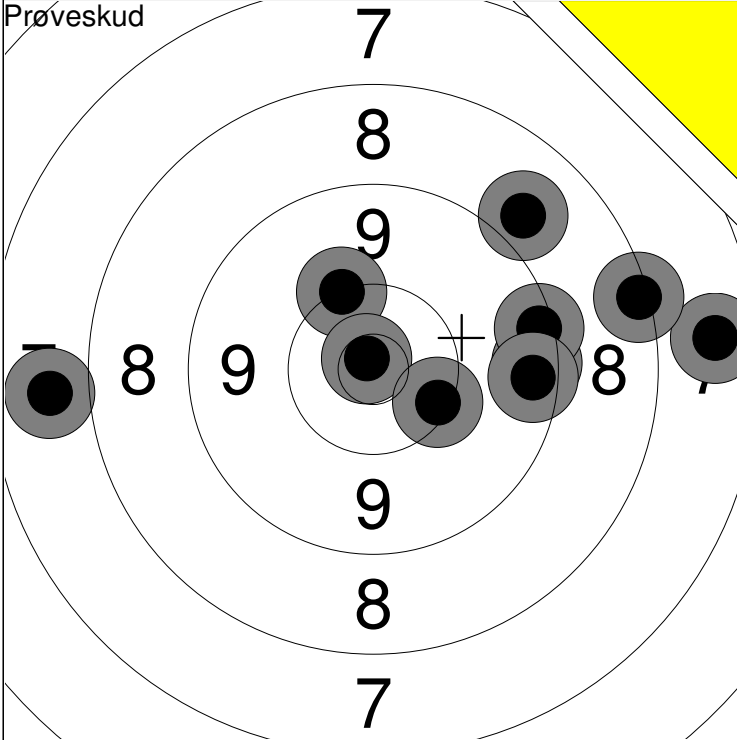

1: 7.8 ←	6: 8.3 →	Serie	87
2: 10.2 ↗	7: 9.3 →		
3: 10.8x ↗	8: 8.9 ↗	Total	0
4: 7.6 →	9: 10.3 ↘		
5: 9.4 →	10: 9.4 →		

11: 9.0 →	Serie	19
12: 10.5x ↗		
Total		0

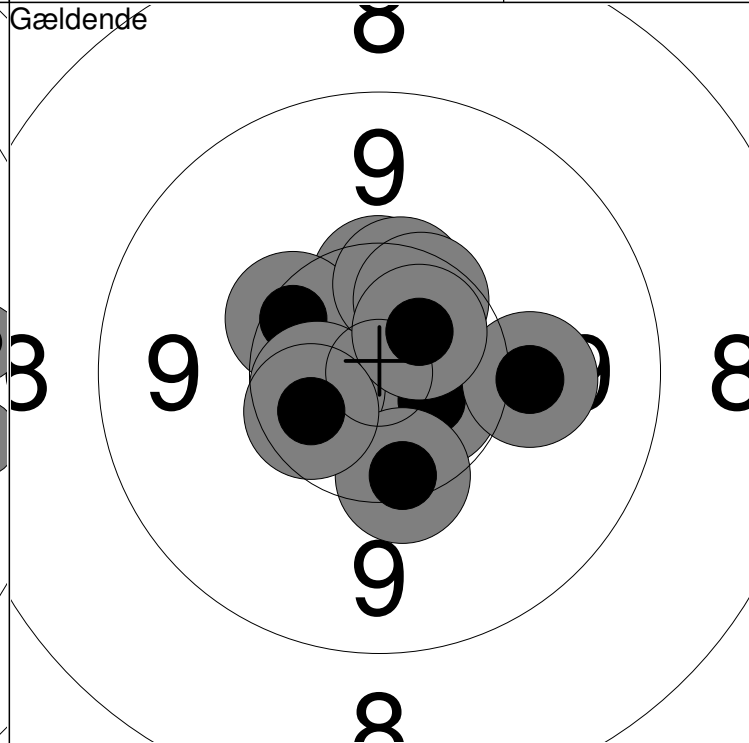
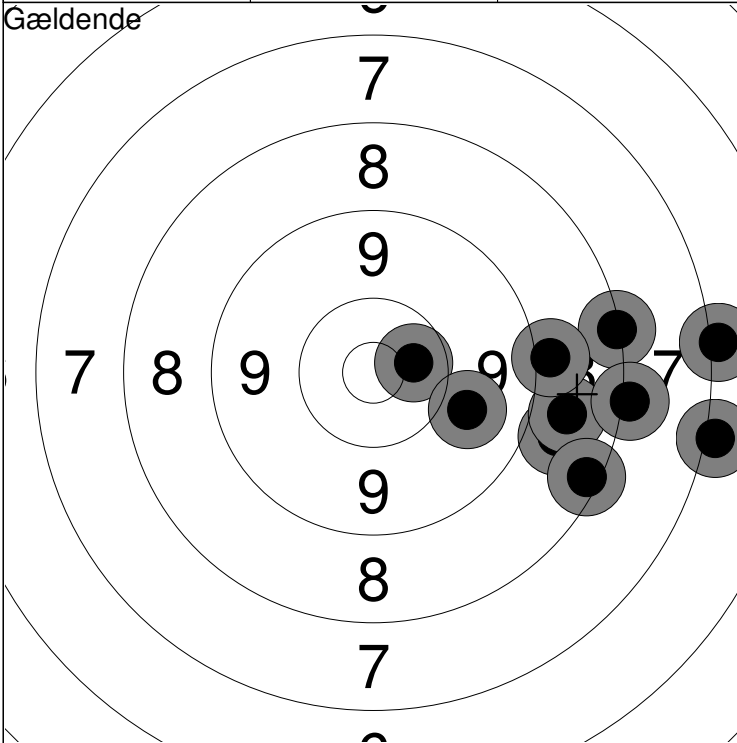

1: 10.5x →	6: 7.1 →	Serie	82
2: 8.8 →	7: 8.3 ↘		
3: 8.2 →	8: 8.1 →	Total	82
4: 7.1 →	9: 9.9 ↘		
5: 8.8 →	10: 9.0 →		

11: 10.6x ↘	16: 10.6x ←	Serie	100
12: 10.4 ↑	17: 10.4x ↗		
13: 10.3 ↖	18: 10.6x ↗	Total	182
14: 10.4 ↑	19: 10.3 ↓		
15: 10.0 →	20: 10.5x ↖		

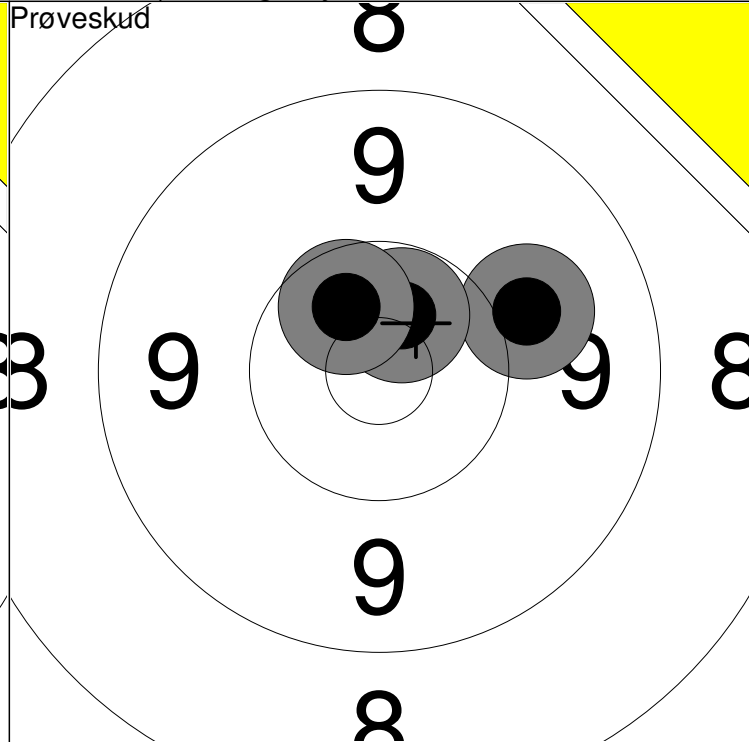
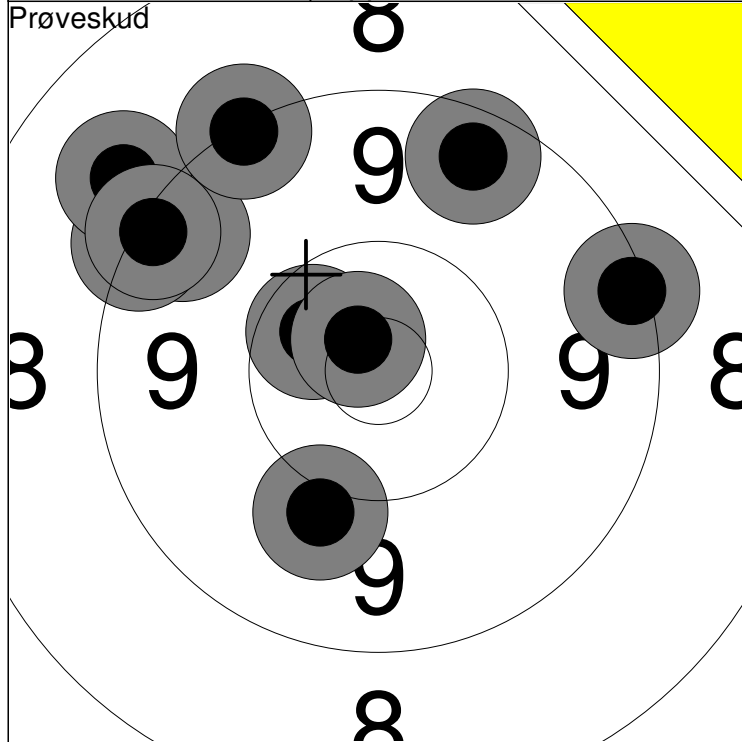

1: 9.3 →	6: 8.9 ↗	Serie	92
2: 9.5 ↗	7: 10.7x ↗		
3: 10.0 ↓	8: 9.3 ↗	Total	0
4: 10.5x ↖	9: 9.5 ↗		
5: 9.2 ↖	10: 9.2 ↗		

11: 10.0 →	Serie	30
12: 10.6x ↗		
13: 10.5x ↖	Total	0

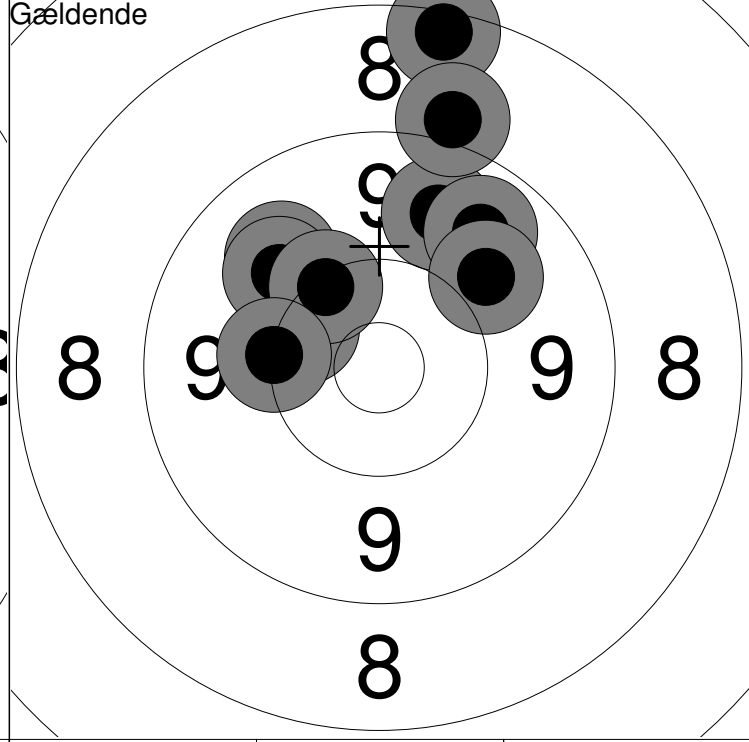
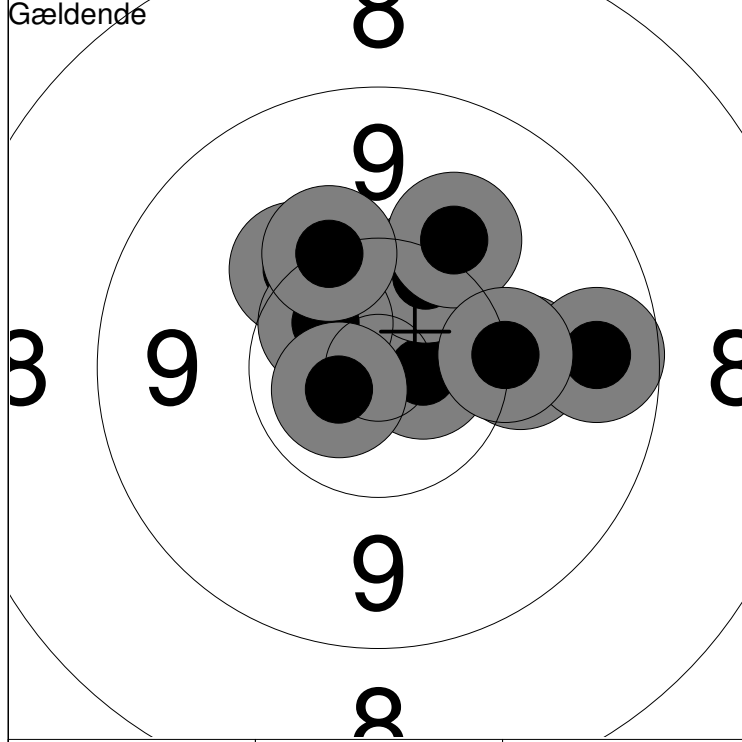

1: 10.2 ↗	6: 10.5x ↗	Serie	99
2: 10.7x →	7: 10.0 ↗		
3: 10.1 →	8: 10.2 ↗	Total	99
4: 9.6 →	9: 10.2 →		
5: 10.3 ↗	10: 10.7x ↖		

11: 10.3 ↖	Serie	92
12: 9.7 ↗		
13: 8.3 ↗	Total	191
14: 9.9 ↗		
15: 9.9 ↖		

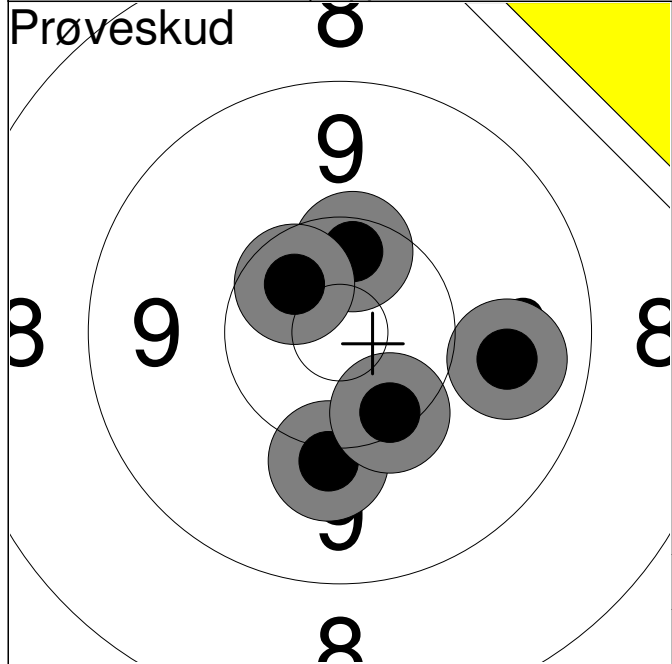

	1:	9.8	→
	2:	10.1	↓
	3:	10.3	↙
	4:	10.4	↑
	5:	10.5x	↗
Serie			49.0
Total			0.0

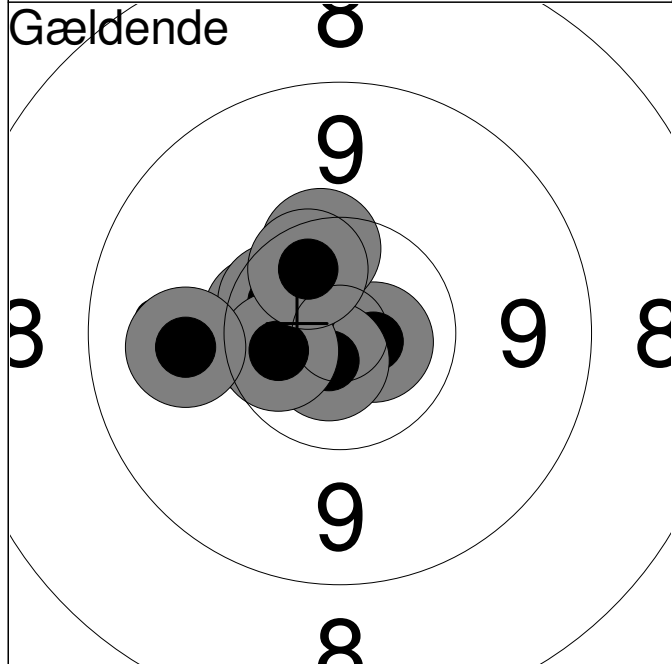

	1:	10.4x	←
	2:	10.5x	←
	3:	10.7x	→
	4:	10.4	↑
	5:	10.8x	↓
	6:	10.4x	←
	7:	10.5x	↗
	8:	10.5x	←
	9:	10.5x	↑
	10:	9.9	←
Serie			99.0
Total			99.0

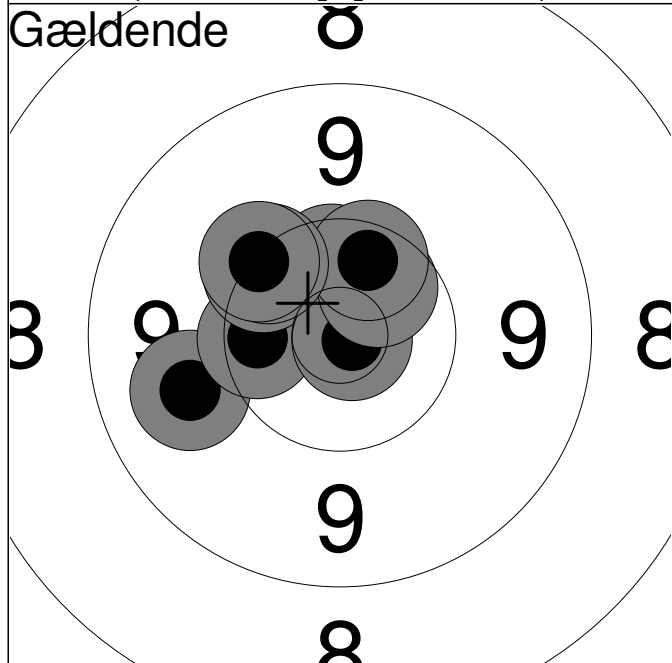

	11:	9.9	←
	12:	10.6x	↗
	13:	10.4	←
	14:	10.3	↗
	15:	10.5x	↑
	16:	10.9x	↓
	17:	10.5x	↗
	18:	10.4	↑
	19:	10.3	↗
	20:	10.2	↗
Serie			99.0
Total			198.0

Hold	Skive		
14	9	Mikkel Hald	
50m	Hobro Egnens Skytteforening		BK3
Jeppestævne 2015		Aalborg Skyttekreds	
Prøveskud 	1:	8.4	→
	2:	7.2	↑
	3:	7.5	↖
	4:	10.5x	↓
	5:	10.5x	↑
	6:	8.7	↗
	7:	9.5	↑
	8:	10.8x	←
	9:	9.6	↑
	10:	9.2	↑
	Serie		87.0
Total		0.0	
Gældende 	1:	10.0	→
	2:	10.0	↑
	3:	10.2	↖
	4:	9.8	↑
	5:	10.0	←
	6:	10.7x	↑
	7:	10.4	↗
	8:	10.4	↑
	9:	10.3	↓
	10:	10.3	→
Serie		99.0	
Total		99.0	
Gældende 	11:	9.7	←
	12:	10.2	↑
	13:	9.9	↖
	14:	9.8	←
	15:	9.9	↓
	16:	9.8	↓
	17:	9.8	↗
	18:	10.1	↓
	19:	9.9	↖
	20:	10.2	←
Serie		93.0	
Total		192.0	

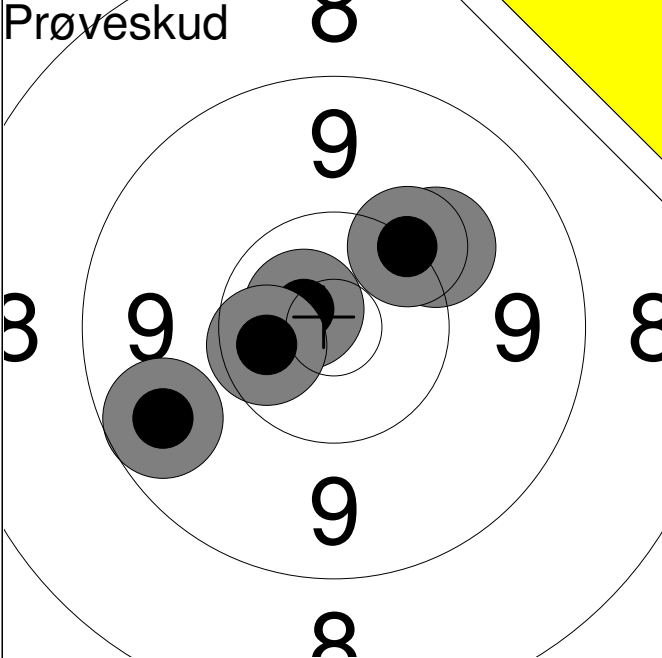
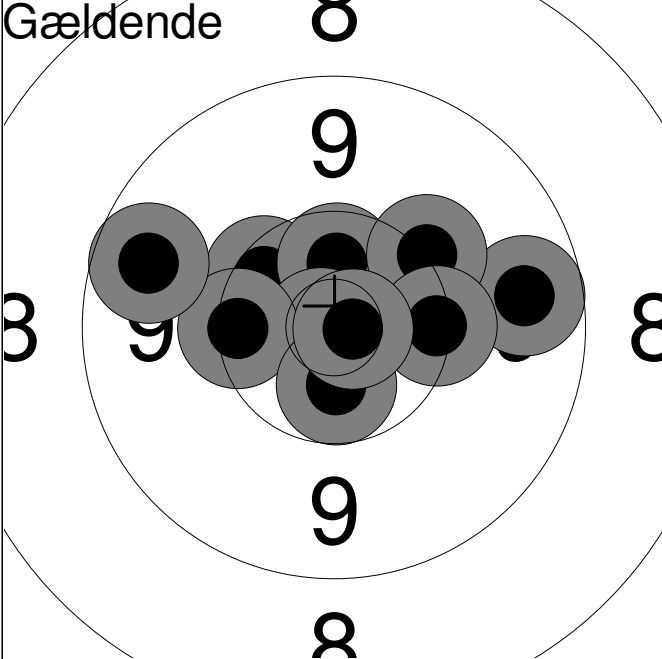
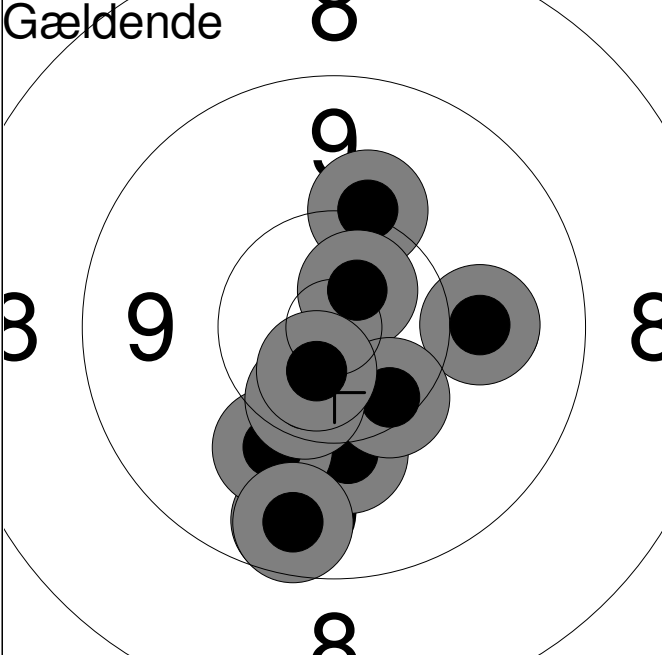
Hold	Skive	Rikke Hald	
14	10		
50m	Hobro Egnens Skytteforening		BK3
	Jeppestævne 2015		Aalborg Skyttekreds
Prøveskud		1: 10.7x ↖	
		2: 10.1 ↗	
		3: 10.2 ↗	
		4: 9.6 ↙	
		5: 10.5x ↙	
		Serie	49.0
		Total	0.0
Gældende		1: 9.6 →	
		2: 10.4 ↖	
		3: 10.5x ↑	
		4: 10.1 ↗	
		5: 10.2 →	
		6: 10.9x ↖	
		7: 10.3 ↖	
		8: 10.6x ↓	
		9: 9.6 ↖	
		10: 10.8x →	
		Serie	98.0
		Total	98.0
Gældende		11: 10.1 ↑	
		12: 9.6 ↓	
		13: 10.1 ↓	
		14: 10.0 →	
		15: 10.7x ↗	
		16: 10.0 ↙	
		17: 10.3 ↓	
		18: 10.4x ↓	
		19: 10.6x ↓	
		20: 9.6 ↓	
		Serie	98.0
		Total	196.0

Hold	Skive	Jørgen Thomsen		
15	1			
50m	Hobro Egnens Skytteforening		MÅ1	
Jeppestævne 2015		Aalborg Skyttekreds		
Prøveskud		1:	10.1	→
		2:	9.9	↑
		3:	9.9	↗
		4:	10.4	↖
		5:	10.5x	→
		6:	10.3	↘
		7:	9.8	↖
		8:	9.6	↖
		9:	10.3	↘
		10:	10.6x	←
		Serie		96.0
Total		0.0		
Gældende		1:	10.6x	→
		2:	10.7x	↑
		3:	10.4	↘
		4:	9.9	↗
		5:	10.1	↑
		6:	10.5x	↘
		7:	10.0	→
		8:	10.1	←
		9:	10.6x	→
		10:	10.5x	↗
		Serie		99.0
Total		99.0		
Gældende		11:	10.9x	→
		12:	10.1	↘
		13:	10.4x	↗
		14:	10.0	↗
		15:	9.8	↘
		16:	10.5x	←
		17:	10.2	↖
		18:	10.7x	↗
		19:	10.7x	←
		20:	10.4	↗
		Serie		99.0
Total		198.0		

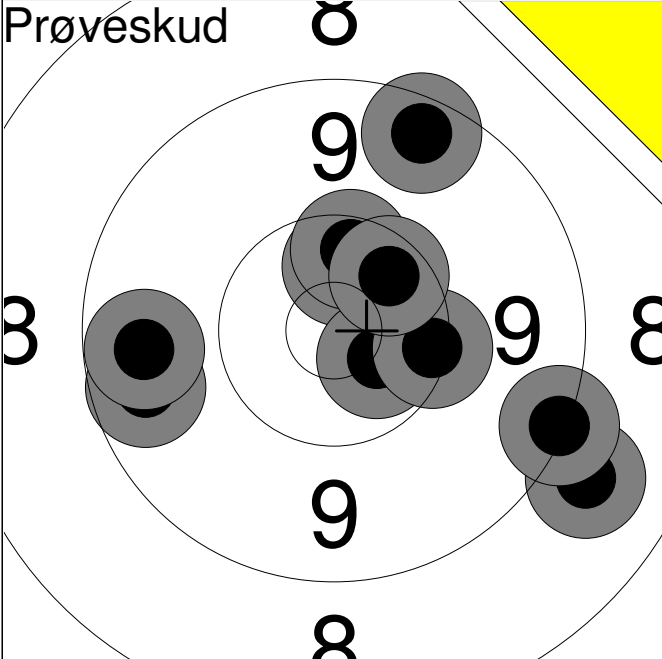
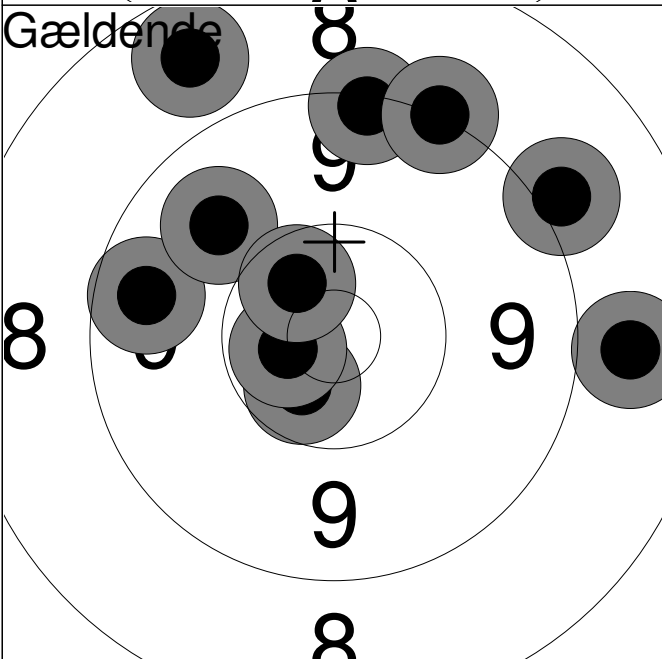
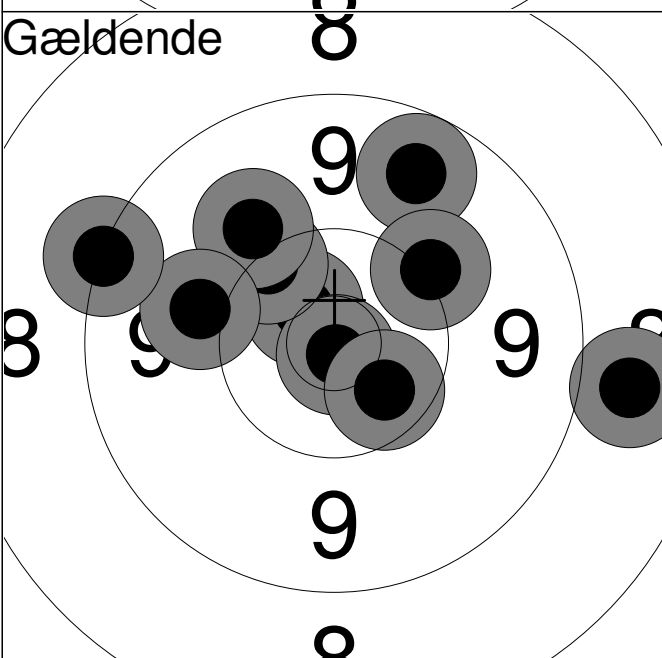
Hold	Skive	Gitte Hansen	
15	3		
50m	Hobro Egnens Skytteforening	MÅ2	
	Jeppestævne 2015	Aalborg Skyttekreds	
Prøveskud		1: 8.9	↘
		2: 9.2	→
		3: 10.5x	↑
		4: 9.6	←
		5: 10.6x	↘
		6: 9.4	↑
		7: 10.3	→
		8: 10.4	↑
		9: 9.6	←
		10: 10.4x	↗
		Serie	94.0
		Total	0.0
Gældende		1: 10.5x	↙
		2: 8.8	→
		3: 10.6x	←
		4: 8.7	↑
		5: 9.6	←
		6: 9.3	↑
		7: 9.8	↗
		8: 9.2	↑
		9: 9.0	↗
		10: 10.5x	↗
		Serie	91.0
		Total	91.0
Gældende		11: 10.6x	↗
		12: 10.9x	↙
		13: 10.2	↗
		14: 8.8	→
		15: 10.0	↗
		16: 10.5x	↙
		17: 10.0	←
		18: 9.6	↑
		19: 10.1	↗
		20: 9.2	←
		Serie	96.0
		Total	187.0

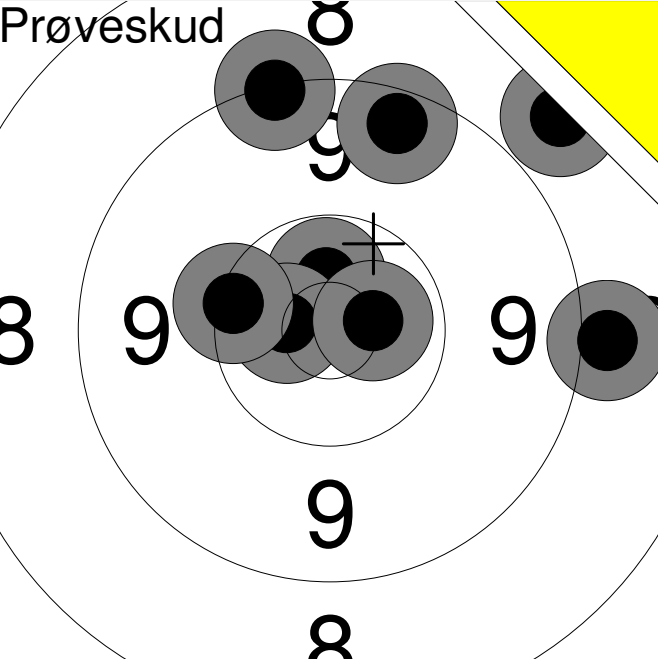
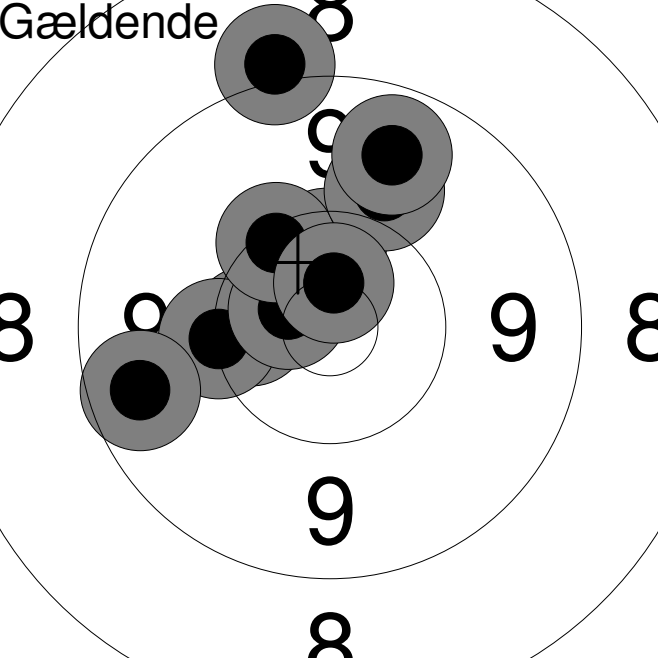
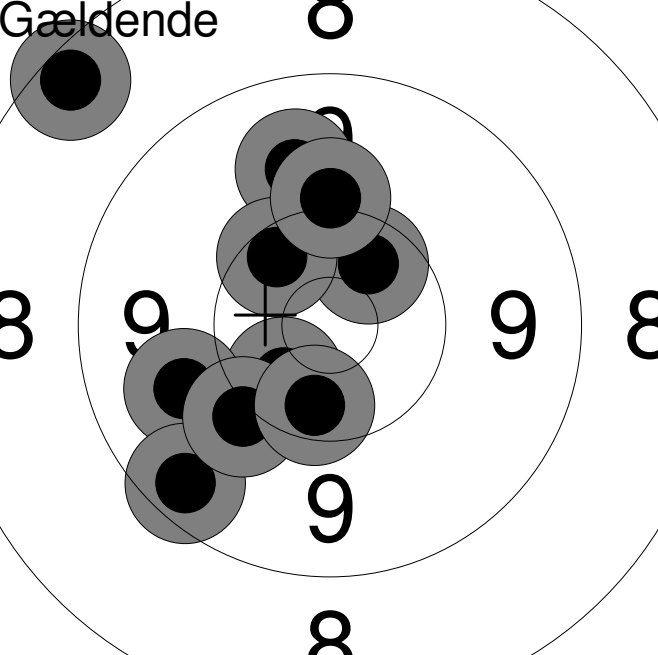
Hold	Skive	Johnni Hald	
15	5		
50m	Hobro Egnens Skytteforening		MÅ2
Jeppestævne 2015		Aalborg Skyttekreds	
Prøveskud 	1:	9.4	↑
	2:	10.6x	↑
	3:	9.2	↑
	4:	10.7x	←
	5:	10.3	←
	6:	9.0	→
	7:	8.7	↗
	8:	10.6x	→
	Serie		75.0
Total		0.0	
Gældende 	1:	10.4	←
	2:	9.0	↑
	3:	10.2	←
	4:	10.6x	←
	5:	10.4	↑
	6:	10.3	↗
	7:	9.6	←
	8:	9.9	↑
	9:	9.7	↑
	10:	10.6x	↑
Serie		96.0	
Total		96.0	
Gældende 	11:	10.5x	↗
	12:	8.4	↖
	13:	10.5x	↙
	14:	9.9	←
	15:	9.9	↑
	16:	9.5	↙
	17:	10.1	↙
	18:	10.4	↗
	19:	10.4	↓
	20:	10.1	↑
	Serie		95.0
Total		191.0	

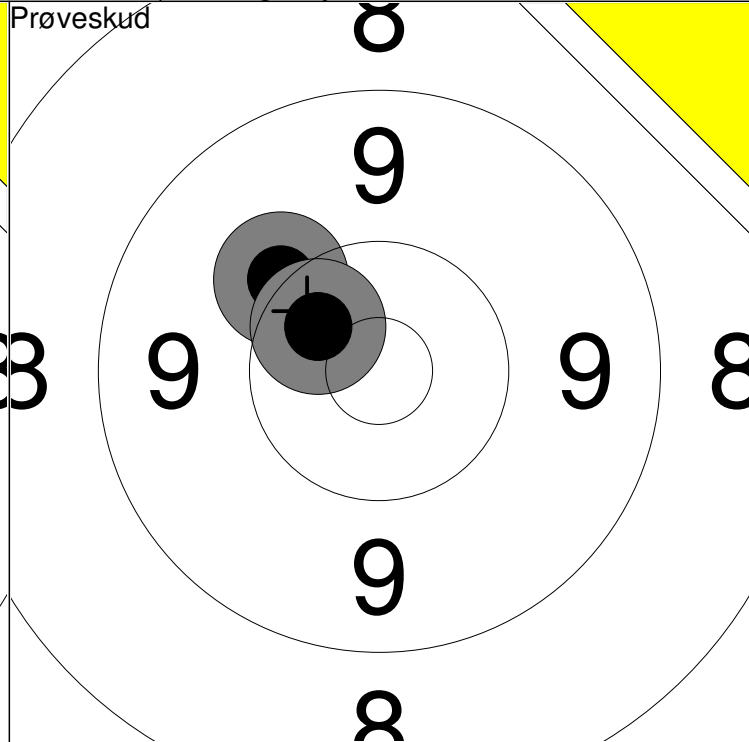
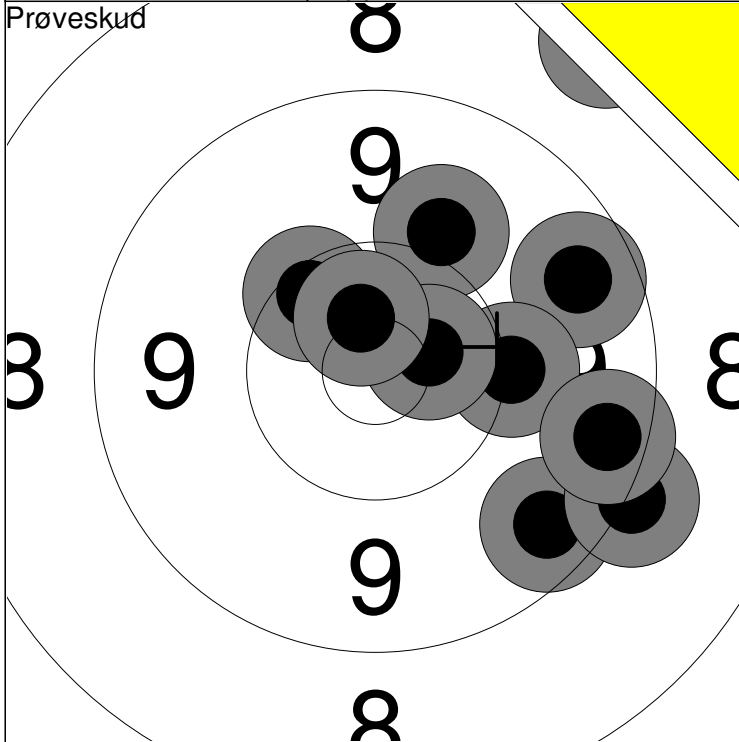

1: 8.4 ↗	6: 10.6x →	Serie	94
2: 10.0 ↗	7: 9.5 ↘		
3: 10.3 ↖	8: 10.6x ↗	Total	0
4: 9.6 →	9: 9.1 ↘		
5: 10.1 →	10: 9.4 ↘		

11: 10.1 ↗	Serie	20
12: 10.5x ↗		
Total		0

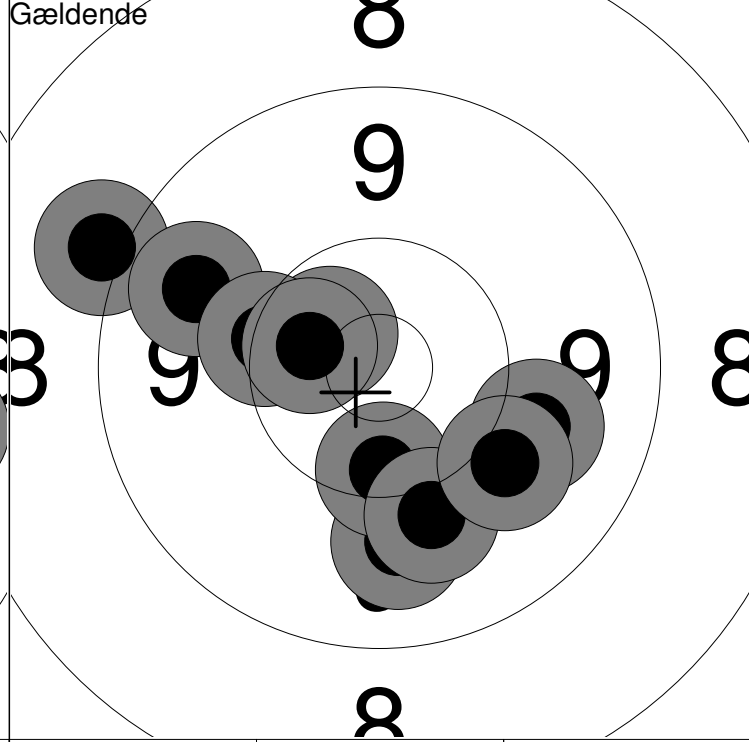
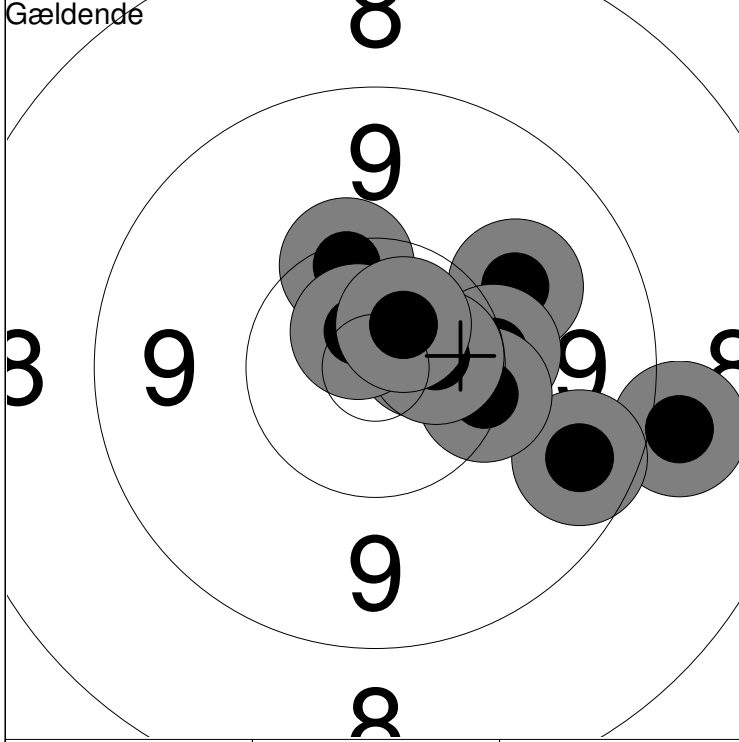

1: 9.0 →	6: 10.3 ↗	Serie	98
2: 10.0 ↗	7: 10.6x →		
3: 10.2 →	8: 10.6x →	Total	98
4: 9.6 ↘	9: 10.7x ↗		
5: 10.3 →	10: 10.6x ↗		

11: 9.0 ↗	16: 10.0 ↘	Serie	96
12: 9.9 ↘	17: 9.7 ↗		
13: 9.9 ↘	18: 10.2 ←	Total	194
14: 10.6x ↗	19: 10.5x ←		
15: 10.3 ↘	20: 10.0 ↘		

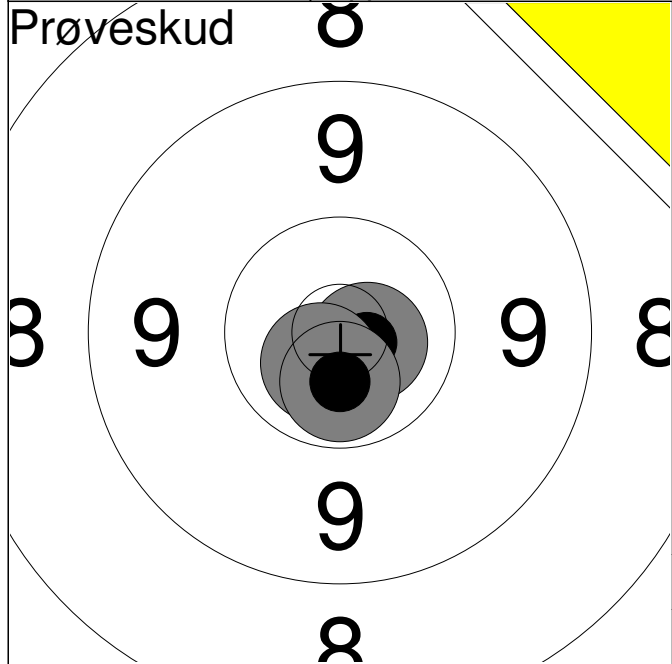

1:	10.8x	→
2:	10.7x	↙
3:	10.6x	↓
Serie		30.0
Total		0.0

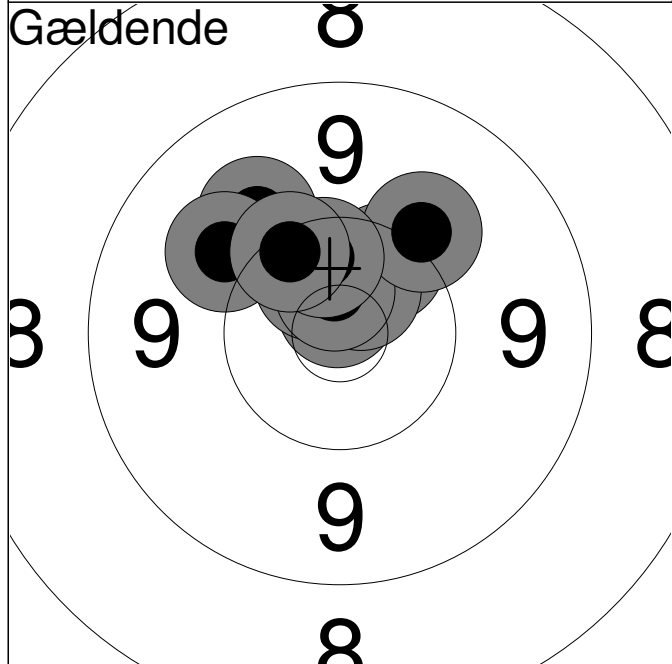

1:	10.4	↗
2:	10.8x	↑
3:	10.5x	↗
4:	10.6x	↗
5:	10.7x	↑
6:	10.1	↗
7:	10.0	↗
8:	10.4x	↑
9:	10.0	↗
10:	10.3	↗
Serie		100.0
Total		100.0

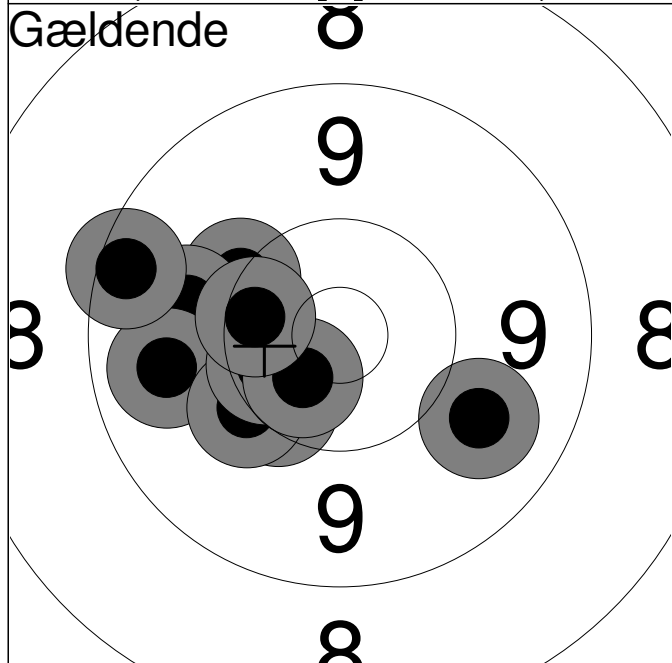

11:	10.2	↗
12:	9.9	←
13:	9.7	←
14:	9.4	←
15:	10.3	↙
16:	10.1	↙
17:	10.4	←
18:	10.6x	↙
19:	10.4	←
20:	9.8	↘
Serie		96.0
Total		196.0

Hold	Skive	Mikkel Hald		
15	9	Hobro Egnens Skytteforening		MB3
50m		Jeppestævne 2015	Aalborg Skyttekreds	
Prøveskud		1:	9.9	↑
		2:	9.4	↑
		3:	10.5x	→
		4:	9.9	↘
		5:	10.6x	←
		6:	9.8	↘
		7:	9.8	←
		8:	9.8	↗
		9:	10.4	→
		Serie		84.0
Total		0.0		
Gældende		1:	10.0	←
		2:	9.8	↘
		3:	10.1	↘
		4:	10.1	←
		5:	10.1	↘
		6:	9.9	↘
		7:	9.7	↘
		8:	10.5x	↘
		9:	8.9	←
		10:	9.5	↘
Serie		94.0		
Total		94.0		
Gældende		11:	8.9	←
		12:	9.8	←
		13:	9.2	↘
		14:	10.1	←
		15:	10.1	↘
		16:	10.0	←
		17:	9.8	↘
		18:	10.2	↘
		19:	10.8x	↘
		20:	9.8	←
Serie		94.0		
Total		188.0		

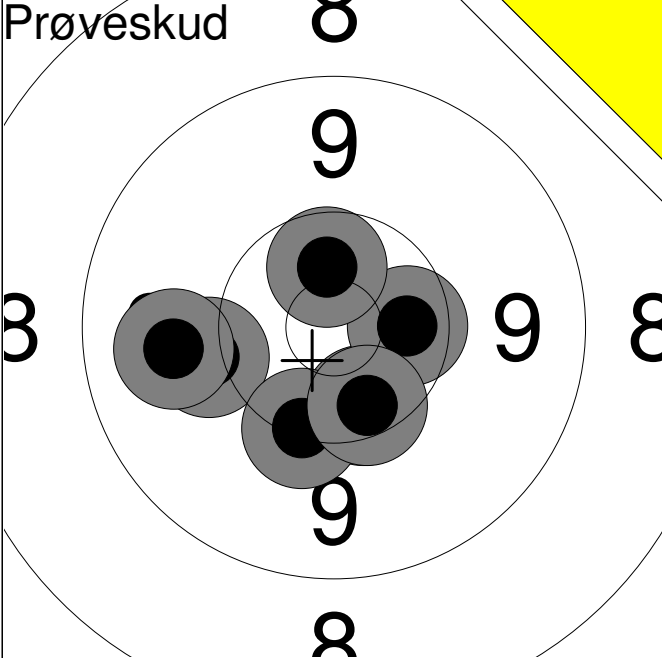
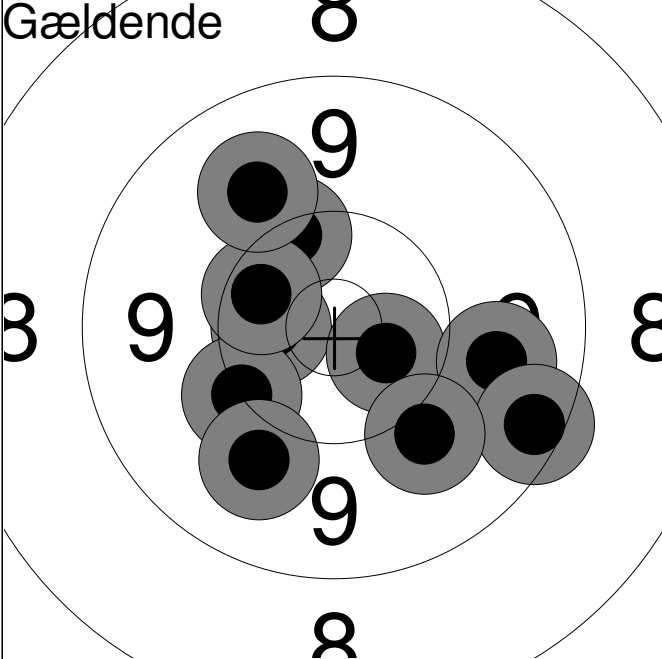
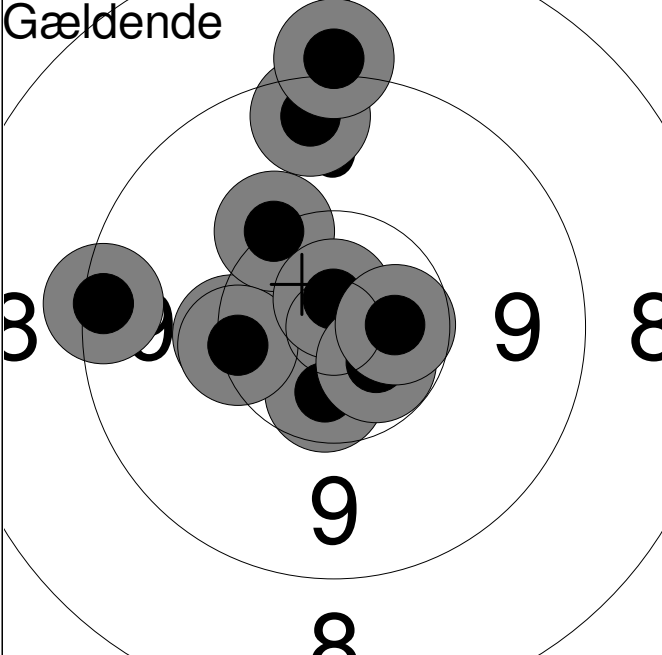
Hold	Skive	Rikke Hald	
15	10		
50m	Hobro Egnens Skytteforening	MB3	
	Jeppestævne 2015	Aalborg Skyttekreds	
Prøveskud		1: 10.4	↓
		2: 10.1	←
		3: 10.4x	→
		4: 9.8	←
		5: 10.2	↓
		6: 10.5x	↑
		7: 10.4	↓
		Serie	69.0
		Total	0.0
Gældende		1: 10.5x	←
		2: 10.3	↑
		3: 10.6x	↓
		4: 10.2	←
		5: 10.4	↑
		6: 9.8	↓
		7: 9.9	↑
		8: 9.4	↓
		9: 9.9	↓
		10: 10.0	↓
		Serie	96.0
		Total	96.0
Gældende		11: 10.3	←
		12: 9.5	↑
		13: 10.5x	↓
		14: 9.1	↑
		15: 10.2	↑
		16: 9.3	←
		17: 10.3	←
		18: 10.8x	↑
		19: 10.6x	↓
		20: 10.5x	→
		Serie	97.0
		Total	193.0

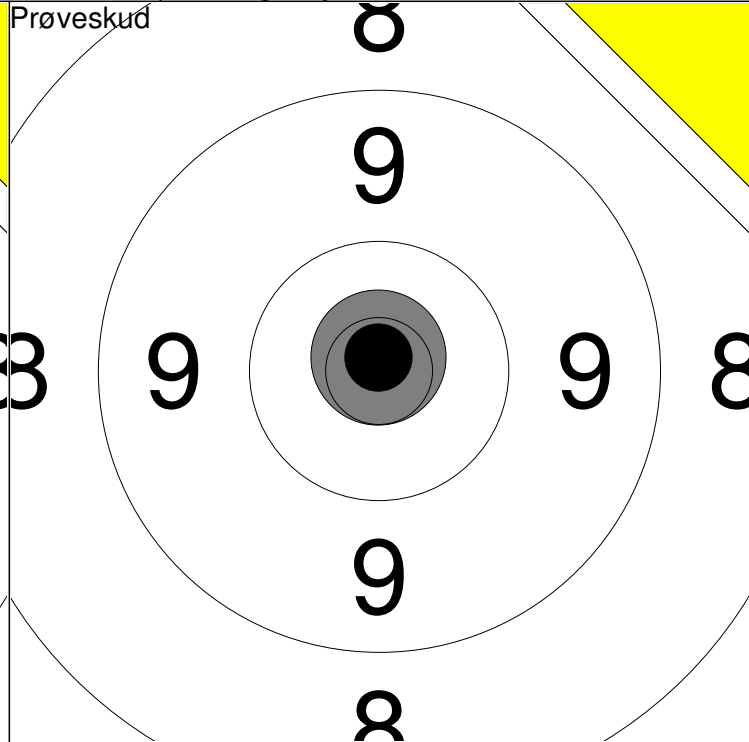
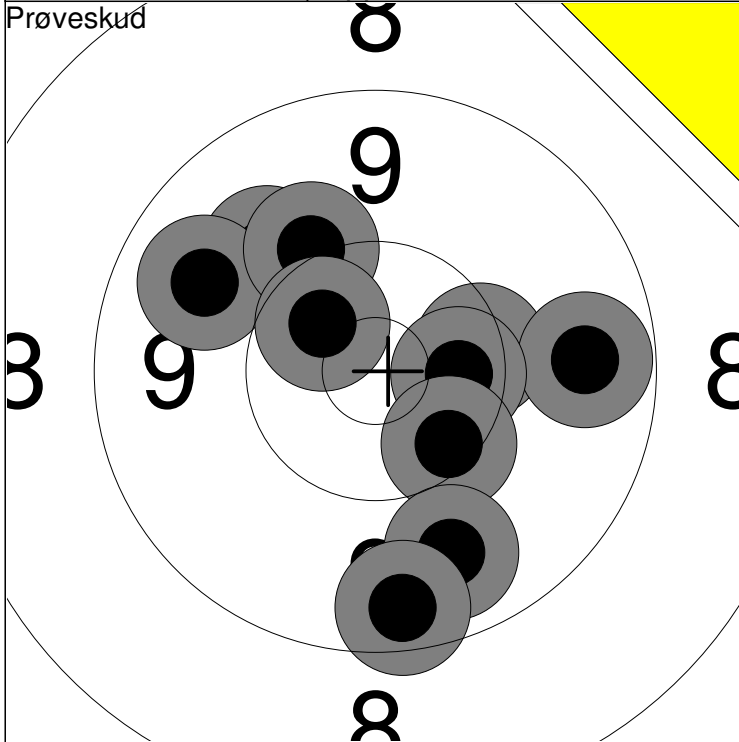

1: 10.3 →	6: 10.3 ↓	Serie	96
2: 9.6 →	7: 9.7 ↓		
3: 10.4x →	8: 10.1 ↗	Total	0
4: 10.0 ↗	9: 10.5x ↗		
5: 9.8 ↖	10: 9.5 ↓		

11: 10.9x ↑		Serie	10
		Total	0

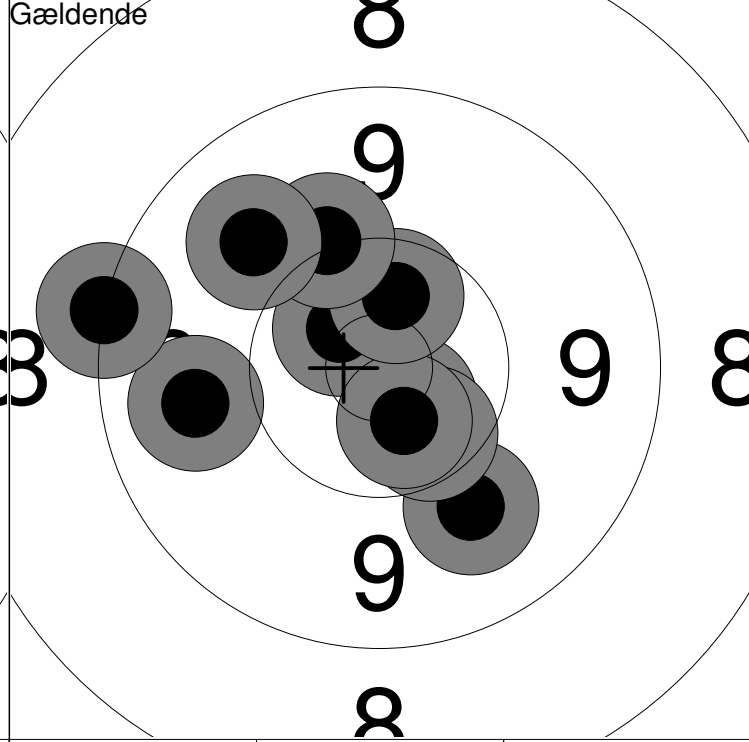
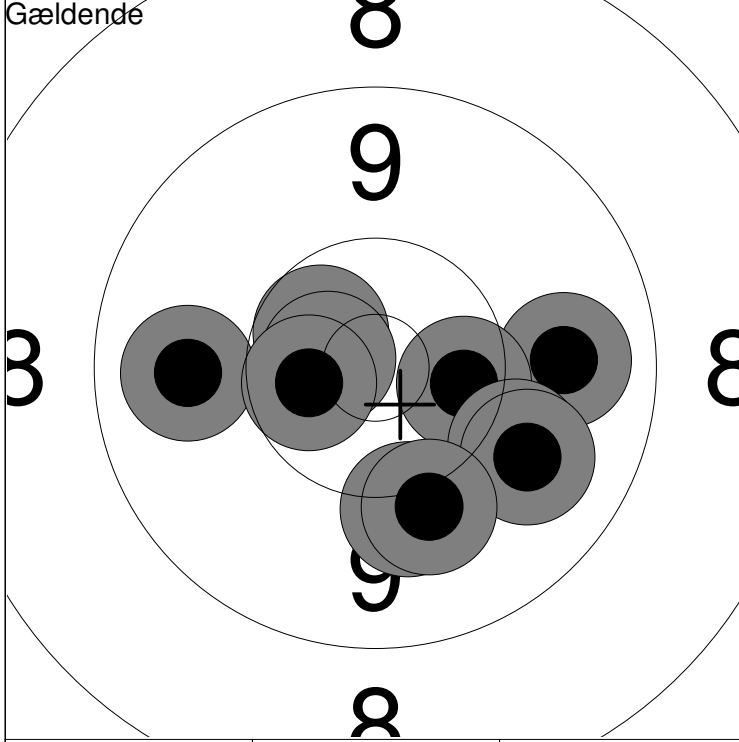

1: 9.8 →	6: 10.7x ←	Serie	97
2: 10.4 →	7: 10.5x ←		
3: 10.6x ↗	8: 10.1 ↓	Total	97
4: 10.0 ↓	9: 9.9 ↓		
5: 9.8 ←	10: 10.0 ↓		

11: 10.7x ↓	16: 10.5x ↑	Serie	96
12: 10.6x ↗	17: 9.8 ←		
13: 9.9 ↓	18: 10.1 ↗	Total	193
14: 10.4x ↓	19: 9.2 ←		
15: 10.6x ↓	20: 9.9 ↗		